

A-VarioBell – Door phone

A-VarioBell

*VBD-00, VBD-01, VBD-02
VBD5-mod, VBD10-mod, VBDKey*



User and service manual
Version 1.0

Welcome

Congratulation on purchasing the “A-VarioBell Door Entry system“. DoorPhone A-VarioBell is universal doorphone for analog line without restriction of connection (universal ease of use for all analog lines and for analog PBXs). Latest news on A-VarioBell can be found at this [link](#).

Basic features:

- A-VarioBell mechanical solution allows modularity from 1 to 87 buttons with option of keypad module
- LED name cards lighting
- 2 independent relays with 8 adjustable modes
- Powering possibility of door phone via power supply used for electrical lock feeding as well as for relays mode with permanent status
- Electronical loudness settings (no need to open the unit)
- Adjustable tone detection for hang up or REDIAL
- DTMF programming by phone or by Windows PC via USB cable
- Phone number length 24 digits including * # Flash and Pause
- Exit button
- RTC real time clock chip – automatical switching DAY/NIGHT
- LED signalling of door phone status, optional audio-induction loop
- Acoustical signalling of door phone status

Version V1.0 11.11.2015

ALPHATECH TECHNOLOGIES s.r.o.

Jeremenkova 88

140 00 Praha 4, CZ, EU

Tel. +420 244 467 562

www.alphatechtechnologies.cz

sales@alphatechtechnologies.cz

Contents

1	BASIC DESCRIPTION.....	6
1.1	FEATURES	6
1.2	TERMINOLOGY	7
1.3	VERSION A-VARIOBELL DOOR PHONE AND DIFFERENCES.....	8
1.4	DOOR PHONE SETS	8
1.4.1	<i>Button mModules</i>	8
1.4.2	<i>Mechanical parts</i>	9
1.5	BASIC BOARD CONNECTION	12
1.5.1	<i>Power supply - screw (6)</i>	14
1.5.2	<i>Exit button – screw (8)</i>	14
1.5.3	<i>BUS for buttons extending</i>	14
1.6	CONNECTION OF EXTENDING MODULES VBD10(5)-MOD.....	15
1.6.1	<i>Example of modules connection VBD10-mod</i>	16
1.6.2	<i>Example of modules connection VBD5-mod</i>	17
1.6.3	<i>Buttons numbering</i>	18
1.7	KEYPAD VBDDKEY CONNECTION	21
1.8	BASIC MODULE SIGNALLING ON FRONT PANEL.....	22
2	INSTALLATION.....	23
2.1	MOUNTING.....	23
2.2	CONNECTION	26
2.2.1	<i>Code relay (COSW)</i>	29
2.3	FURTHER OPTIONS	30
2.3.1	<i>TimeRelay</i>	30
2.3.2	<i>Power supply 12V</i>	30
2.3.3	<i>USB programming cable</i>	30
3	DOOR PHONE SYSTEM OPERATION.....	31
3.1	SIGNALLING OVERVIEW	31
3.2	VISITOR AT THE DOOR.....	32
3.2.1	<i>Relays modes</i>	33
3.3	PERSON INSIDE BUILDING.....	34
3.3.1	<i>Outgoing call</i>	34
3.3.2	<i>Incoming call</i>	35
3.3.3	<i>Door phone with keypad – module VBDDKey</i>	35
3.4	ACOUSTIC PATH SETTING	36
4	PARAMETERS PROGRAMMING	37
4.1	PROGRAMMING BY PHONE	37
4.1.1	<i>Programming enter</i>	37
4.1.2	<i>parameters programming</i>	37
4.2	PC PROGRAMMING – PROGRAM A-VARIOBELLSET	38

5 ADJUSTABLE PARAMETERS DESCRIPTION..... 39

- 5.1 DIRECT NUMBERS DIAL – MEMORIES 39
- 5.2 RELAYS..... 40
- 5.3 BASIC PARAMETERS 46
- 5.4 TIME PARAMETERS..... 49
- 5.5 SYSTEM PARAMETERS 53
- 5.6 HANDSFREE PARAMETERS SETTING 56
- 5.7 BASIC SETTING AND ERASING 61
- 5.8 END OF PROGRAMMING..... 61
- 5.9 PARAMETERS OVERVIEW 62

6 TECHNICAL PARAMETERS..... 65

- 6.1 ELEKTRICAL PARAMETERS..... 65
- 6.2 MECHANICAL DIMENSION 66

7 EASY PROGRAMMING TABLE 67

1 Basic description

1.1 Features

- Voice communication is powered from a telephone line;
- Impulse and tone (DTMF) options;
- Storage of 2 24-digit long numbers per button (including*, #, Flash and pause);
- Max connection of 87 button, memories number is 99 (accessible from keypad VBDKey in mode memory numbers dialling)
- Automatic Day/Night switch, programmed weekly by a DTMF code on the internal RTC clock
- Option to prolong a call with * or #;
- Option to connect two independent electronic locks, to open doors
- Potential to use up to 8 relay modes (for an additional bell, gradual door opening etc.);
- Two codes to disconnect the Door Entry System from a phone;
- Two codes to open doors from the phone for 1-impulse and two codes for 2-impulse;
- 3 x 6 code locks for each relay (password from door buttons);
- Can be connected electrically secure lock on the first switch (serial activation code)
- Option to connect an exit button (C);
- Option to disconnect a call by the repeated pressing of a button;
- Option to switch on a 'baby call' regime (no number dialling);
- Option to switch on a regime to suppress the DTMF connection from the microphone;
- Option to switch on a 'ticking' into a call to announce another call;
- Option to switch on acoustic signalling for relay connection;
- Option to set the number of rings before connecting a call;
- Programmable parameters for tone options Flash length and Pause length;
- Programmable parameters for acoustic signalisation;
- Programmable parameters for tone detection;
- Electronic volume setting without the need to open the front cover;
- Option to power from an internal 12V supply (replaces Best Box) (C)
- Easy setting HW with the help of a DIP switch;
- Several firmware options;
- Programmable with PC, via USB cable, and remote DTMF programming;
- Integrated regulated heating of the PCB;
- Switchable name tag lighting;
- Unit earthed for better protection against static electricity

1.2 Terminology

Telephone line	Analogue (2 conductors) connecting to a public telephone network (public line) or to a local telephone system (local line).
Line connection	The start of a telephone connection (the same as picking up a phone handset).
Line disconnection	End of connection (the same as replacing a phone handset).
Option	DTMF - a tone option combination of two tones (chooses also special signs * and #, uses breaking the loop Flash) Impulsive – option by breaking the loop (chooses only digits)
Incoming call	Connection between a A-VarioBell and a phone made by selecting an option on the phone. The A-VarioBell connects the call after set number of rings. The A-VarioBell can be programmed from the phone following a connection by inputting a password.
Outbound call	Connection between the A-VarioBell and a phone made by choosing an option on the A-VarioBell (i.e. Pressing a button).
Call connection	Signalised when following the dialled number is picked up. This signal is not available on an analogue line, but the ringing tone ends and a connection begins. It is difficult to identify the exact moment this occurs.
Code lock	Function for relay connections by inputting a combination of up to 10 buttons or keyboard keys (after pressing the key symbol)
Code relay	between Doorphone A-VarioBell and the electric lock can be connected code relay (COSW - CodeSwitch), which is located at the lock and lock activates only when is the same the specified serial combination of the A-VarioBell and set the code on the board relay (COSW).
External code	Combination of 10 buttons or keyboard keys (after pressing the key symbol) for a relay connection. External = being input on the A-VarioBell outside the building
Internal code	Digits combination dial from phone for relay activation (DTMF). Internal = dial by phone – inside building (phone connected to other PBX extension
RTC	real time clock with backup ACU



The manufacturer continuously improves the product firmware. The technology used allows you to upload to A-VarioBell the latest version of the firmware any time using a standard computer with A-VarioBellSet and USB cable. The latest version of the firmware is available at <http://www.alphatechtechnologies.cz>

1.3 Version A-VarioBell door phone and differences

A-VarioBell door phone system is conceived as system that provides a final solution based on a modular design. The adjustable features and parameters are for maximal version and each version are sorted by usage of those features. Therefore is necessary to set up the parameters for all versions including any add-on parameters for each mechanical solution.

A-VarioBell door phone uses all parameters in default. The analog camera is not included only.

1.4 Door phone sets

Basic module VBD-xx – A-VarioBell basic module has 2 buttons (VBD-02), one button (VBD-01) or no button (VBD-00).

Extending modules VBDx-mod – exist just 2 types:

- VBD5-mod is module with 5 buttons
- VBD10-mod is module with 10 buttons

Advantage is that button numbering is not depending on modules connection but is adjustable by DIP switch which is on each module (via follow).

Last extending module is keypad VBDKey – it is not necessary set up keypad position and not depends on keypad installation. (via follow).

1.4.1 Button mModules

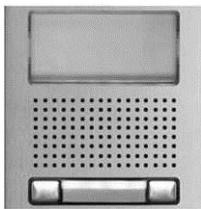

Basic module
VBD-02

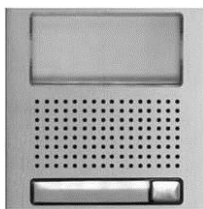

Basic module
VBD-01

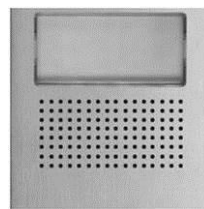

Basic module
VBD-00

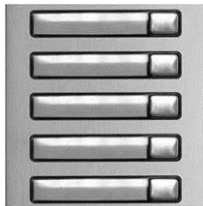

Button module
VBD5-mod

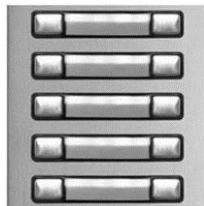

Button module
VBD10-mod

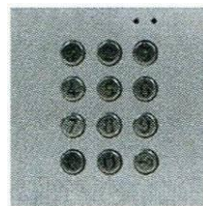

Button module
VBDKey

1.4.2 Mechanical parts

For easier explanation we show mechanical parts for 1, 2 and 3 modules. In one column are max 3 modules. The big set contents max 3 columns (9 modules). For even bigger sets you can put 9 modules set over or next each other.

Mounting box for flush mounting:

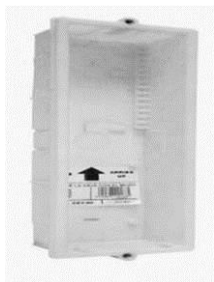

Mounting box-1



Mounting box-2



Mounting box-3

Fixing and covering frame – for flush and surface mounting

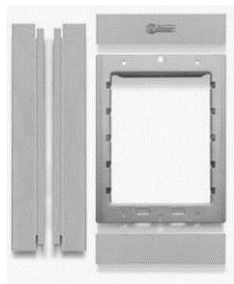

for 1 module

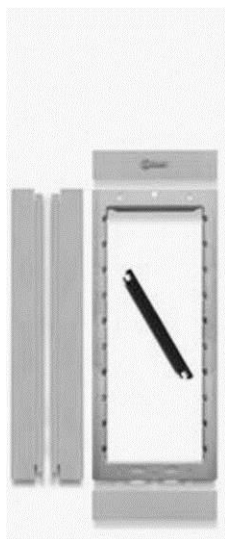

for 2 modules

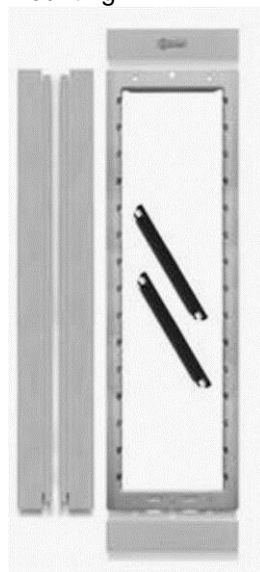

for 3 modules

design frame – flush mounting only

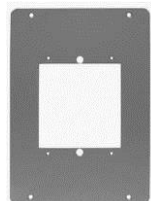

frame-1

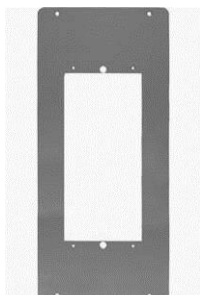

frame-2

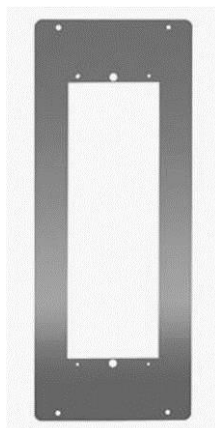

Frame-3

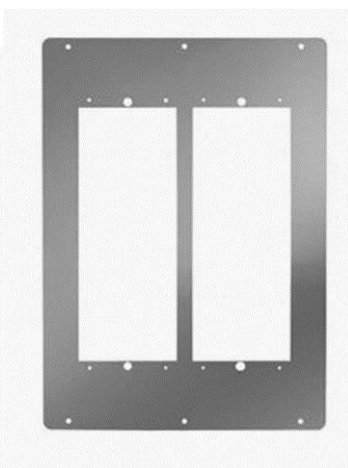

Frame - 3 x 2

roofing shield – flush mounting only

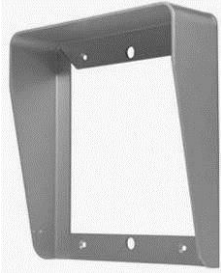

Shield-1

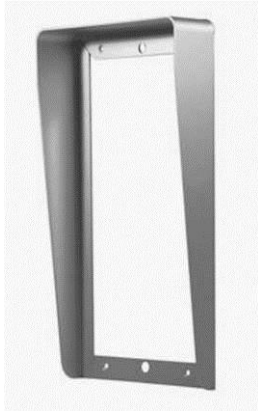

Shield-2

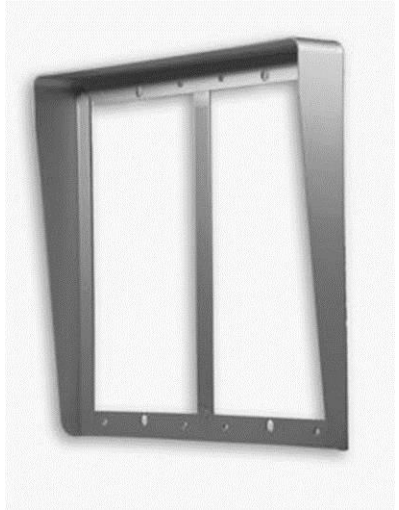

Shield -2 x 2

SMB – surface mounting boxi – surface mounting only (fixing frames are extra)

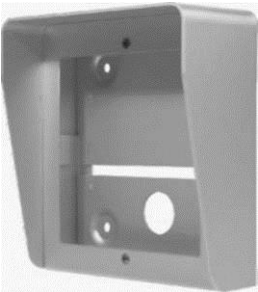

SMB-1

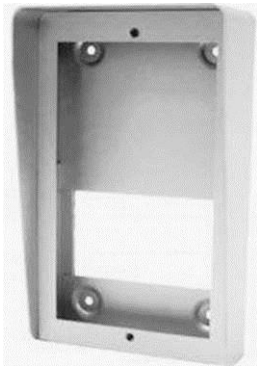

SMB-2

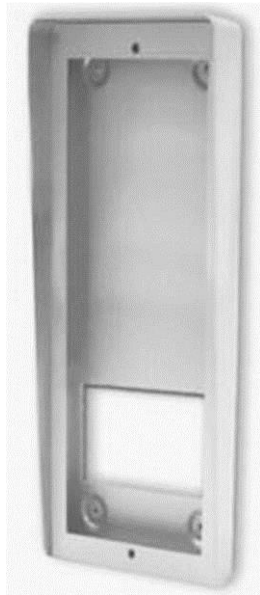

SMB-3

1.5 Basic board connection

All functional and connection elements are marked by red number in circle. Description on next page

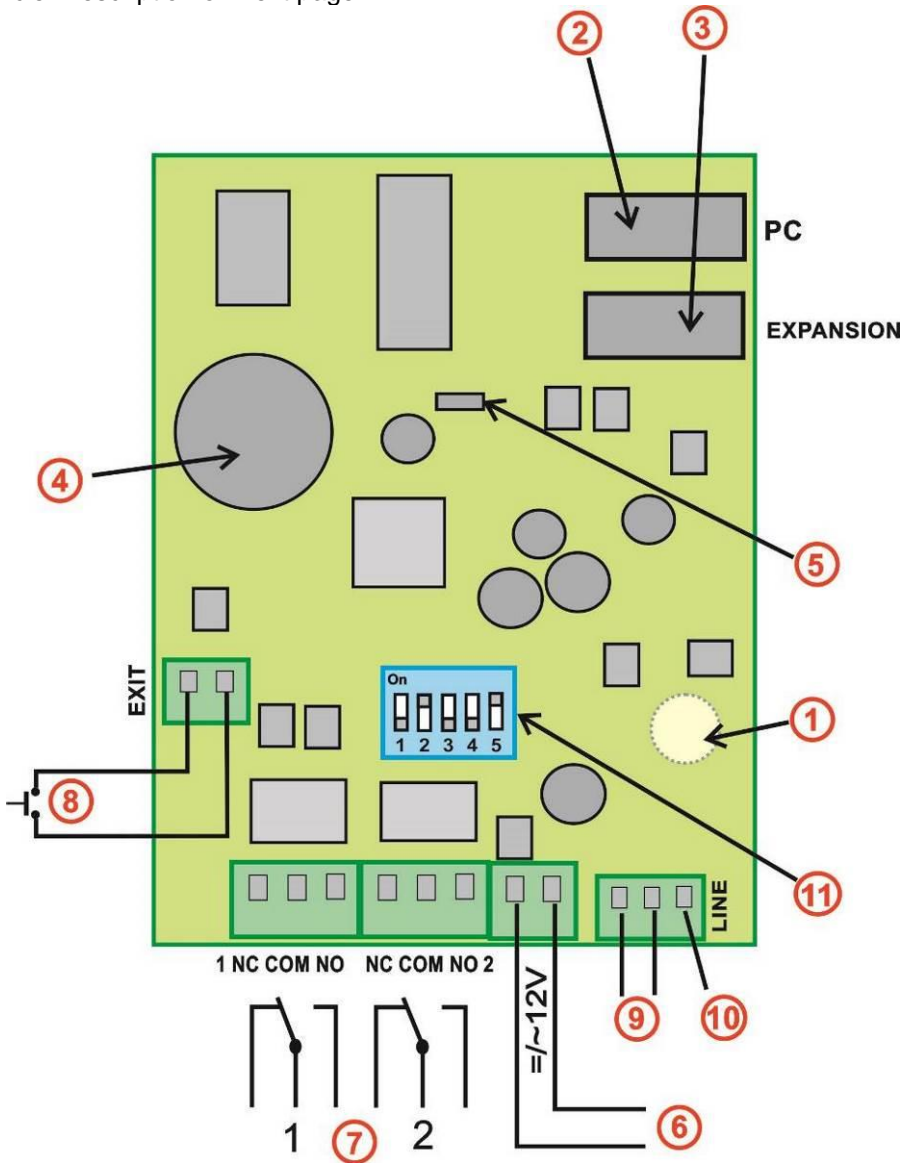

Picture 1 : Basic board of A-VarioBell

1. **Microphone** (placed in plastic cover, output at board bottom)
2. **PC connection connector** – USB cable
3. **BUS connector for** connection extending modules and keypad
4. ACU battery RTC (real time clock chip)
5. **Speaker** – output at board bottom. At top of board is connector for connection of external speaker
6. **12V AC/DC** power supply for:
 - relays control
 - board heating
 - name cards lighting
 - external powering of door phone (DIP 3 and 4)
 - exit button circuit
 - LED signalling on front panel
7. **relays** – are galvanically isolated switchable contacts, max. 48V, max. 1,5A
At relay 1 is available function of code relay (**COSW** – CodeSwitch) (via. page.29)
8. **Exit button** – works in circuit of current loop. The length of connected wires to button might be up 500m. Functionality condition is presents of 12V power on screw (6)
9. Analog **phone line** (not depends on polarity)
10. **Grounding** – connection for grounding against static electricity – protect door phone electronic as same as PBX
11. **DIP switch:**

1 = Servis – used when password is forgotten.
Incoming call is going directly to programming mode where you can setup new password. (do not forget return back to off)

2 = heating – activate integrated board heating

3 = external power supply

4 = External power supply – switching allways 3 and 4 simultaneously. Powering is used from screw 12V (6) and there are 2 reasons for usage:

- using relay in mode 7 or 8 - permanent relay close/open is possible with external powering only. Do not forget setup rameter 64

- connection of door phone to PBX extension which has troubles with current consumption after PBX start (Siemens).

5 = name cards lighting (switch ON/OFF LED lighting for name cards)

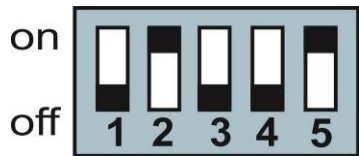

1.5.1 Power supply - screw (6)

Power supply 12V might be **DC or AC**, not depends on polarity, from 12V is max. consumption 250mA.

Power supply is possible use for electrical lock powering . then is recommended power supply 12V/1A

It is possible use power supply **24V DC**. It is mainly suitable during installation where power supply already exists and it is used for example for access system control. Board heating has regulating element for power restriction. The other circuits comply to voltage 24V. You must not use AC power supply! Just DC. During connection not depends on polarity.

Power supply on screw (6) is necessary for following features:

- relay control (powering of relay induction)
- board heating (DIP 2 is activated, current regulation according voltage and temperature)
- name cards lighting (DIP 5 is activated)
- external powering of door phone (DIP 3 and 4). during permanent power supply is possible use relays mode 7 and 8. (caution for rameter 64).
- powering of exit button circuit
- powering of LED signalling on front panel

1.5.2 Exit button – screw (8)

Exit button is designed for direct relays control. At each relay you can setup switching for 1 or 2 pulses. The button (screw (8)) is connected in circuit of current loop powering from 12V (screw (6)). By this way you can connect exit button for cable up to 500m.

1.5.3 BUS for buttons extending

This BUS allows connection of extending buttons up to 87 buttons including keypad. The BUS includes except serial data also power for name cards lighting.

Button module is supply in 2 versions:

VBD10-mod – designed for 10 buttons – 5 in left and 5 in right

VBD5-mod – designed for 5 buttons – 5 in right only

The Keypad **VBDKey** is possible install at BUS whenever you want and it is identify automatically.

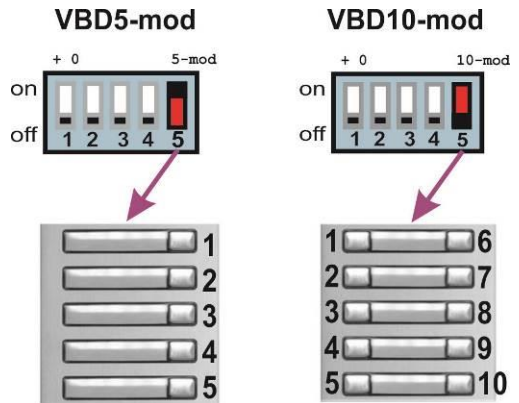

1.6 Connection of extending modules VBD10(5)-mod

Buttons extending modules are **VBD10-mod** with 10 buttons and **VBD5-mod** with 5 buttons. Very important is numbering plan, connection is various, it means that modules you can connect as you desire independently from numbering!

Buttons numbering will be explained later, however it is setup by DIP switch at each button module **(6)**.

VBDx-mod electronic board is connect to A-VarioBell mechanical button panel through screw terminal **(5)** and 3 wire cable **(4)**. The connector **(7)** is not used at version analog A-VarioBell.

Connection to basic module is provide by flat cables K1. **(1)** is connection to basic module, **(2)** is connection of following button module, **(3)** is connection between button modules (still the same flat cable K1)

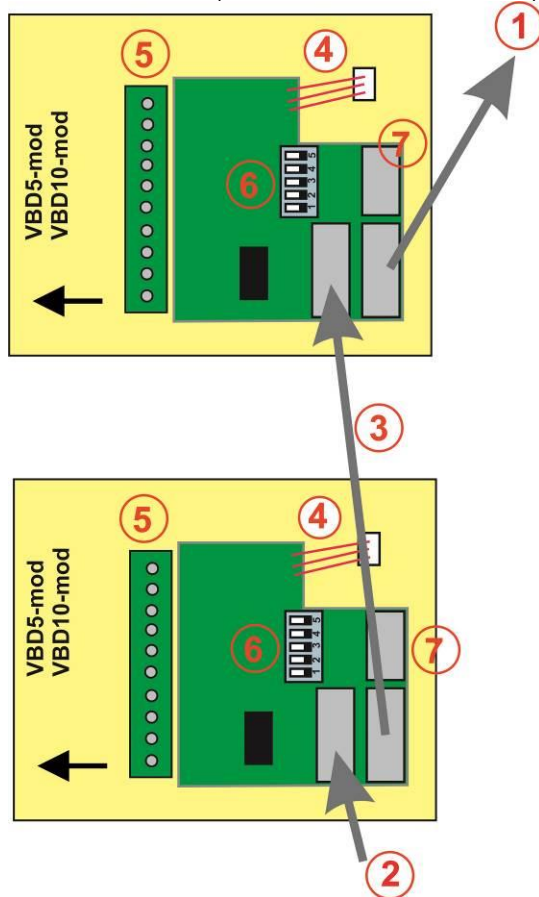

Picture 2: Connection VBD10-mod and VBD5-mod

1.6.1 Example of modules connection VBD10-mod

Mutual connection is provide by flat cable K1. In example is used basic module with 2 buttons (rameter 6# = 2 via page **Chyba! Záložka není definována.**) and in connection is also used keypad module VBDKey. Modules numbering is setup by DIP switches (6) showing allways next to appropriate module. Buttons number response to description in left column next to modules. Keypad module is identify automatically and there is no necessity of any setting. Connection place is various. When cables K1 will be connected alternately nothing will happen and numbering will be kept. (defined by DIP switches on each module).

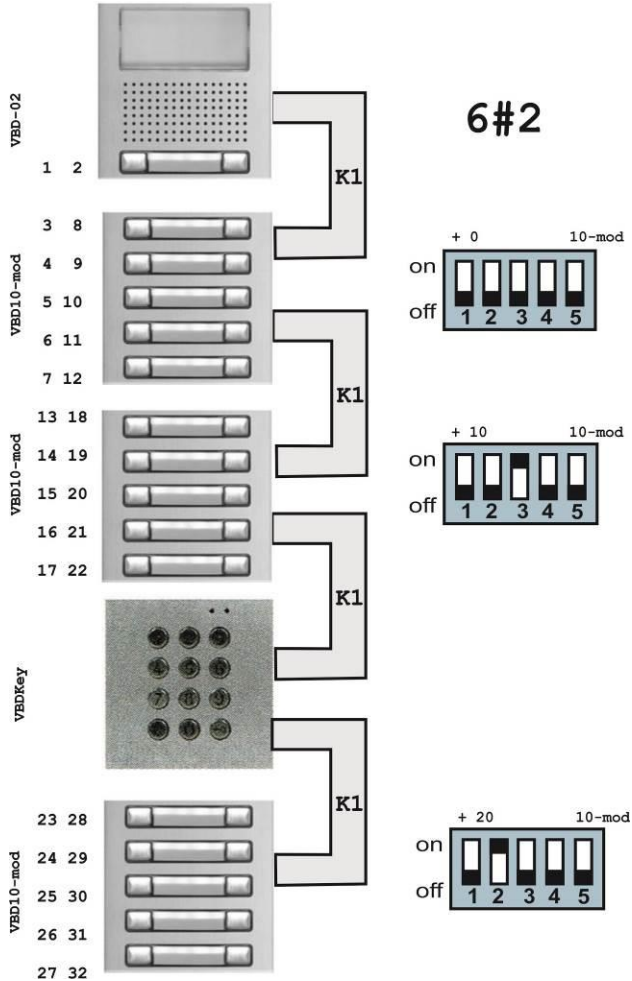

Picture 3 : Mutual connection of modules A-VarioBell VBD10-mod

1.6.2 Example of modules connection VBD5-mod

Mutual connection is provide by flat cable K1. In example is used basic module with 1 button (parameter 6# = 1 via page **Chyba! Záložka není definována.**) and in connection is also used keypad module VBDKey. Modules numbering is setup by DIP switches (6) showing allways next to appropriate module. Buttons number response to description in left column next to modules. Keypad module is identify automatically and there is no necessity of any setting. Connection place is various. When cables K1 will be connected alternately nothing will happen and numbering will be kept. (defined by DIP switches on each module).

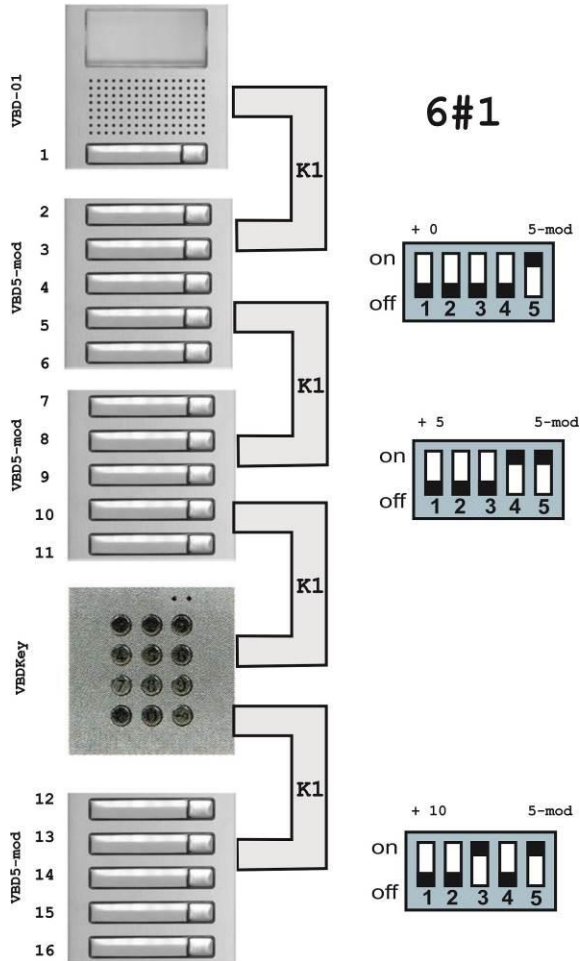

Picture 4: Mutual connection of modules A-VarioBell VBD5-mod

1.6.3 Buttons numbering

Buttons numbering **depends** on 2 settings:

1. Constant in basic module (buttons number on basic module) – parameter 6# - via page **Chyba! Záložka není definována..**
2. DIP switch setting on each button module

Numbering **not depends on** way (order) connection of each button modules.

Constant 6# = [0-1-2] setup in every basic module determine how many buttons has front mechanical panel of basic module. It has influence to button numbering in numbering moving. That is adding this constant to setup button number.

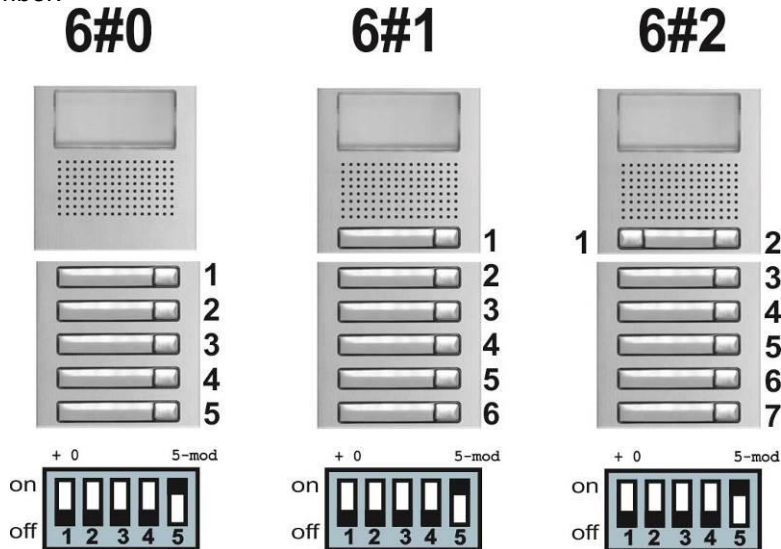

As you can see on picture DIP switch setting of button module is the same but first button of button module VBD5mod is changed from 1 to 3 according setting of constant 6#.

DIP switch setting (6) on button module.

Every DIP position has following functionality:

DIP 1 – 4 = number setting of previous buttons on button modules (basic module is not calculated!!)

DIP 5 = setting of own module, if mechanical front panel has 5 or 10 buttons

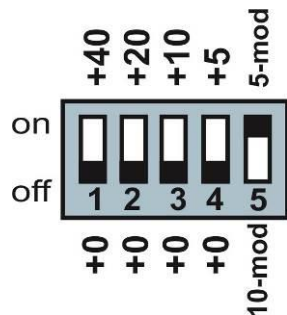

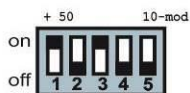
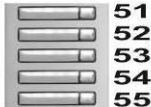
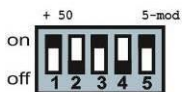
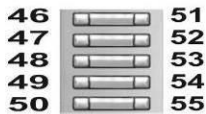
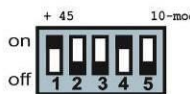
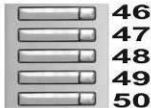
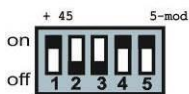
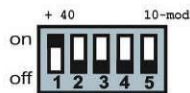
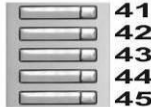
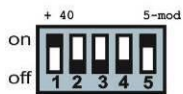
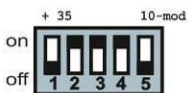
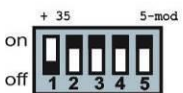
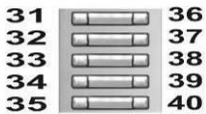
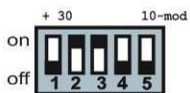
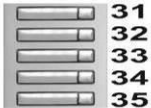
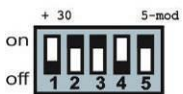
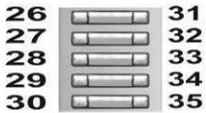
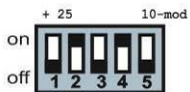
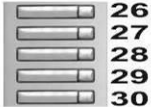
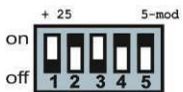
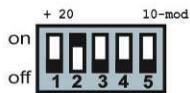
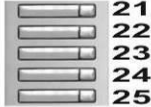
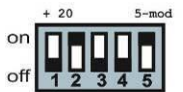
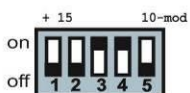
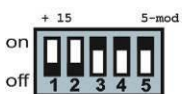
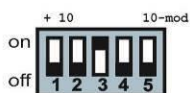
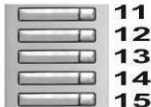
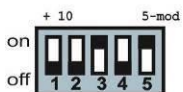
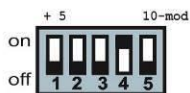
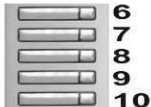
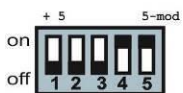
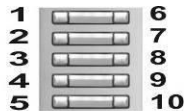
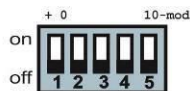
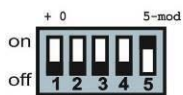

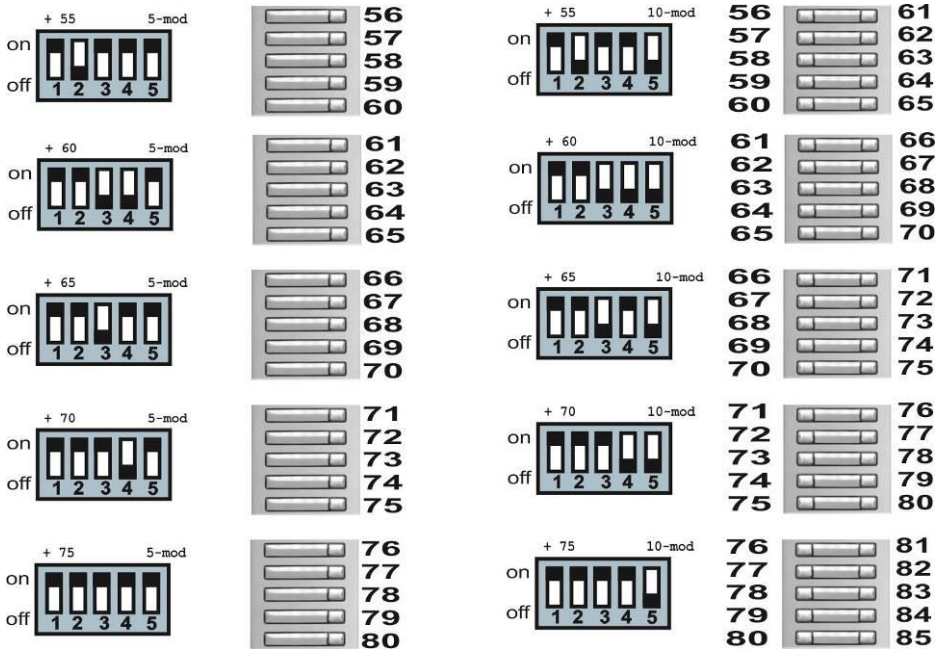





Modules numbering is on the picture. In left part are modules with 5 buttons VBD5-mod and in right part are modules with 10 buttons VBD10-mod.

Module with desired numbering you find on this picture and on the left is DIP switch combination **(6)** which you have to setup on this module.

-  Numbering not depends on mutual modules connection by K1 cables
-  When you connect to system 2 button modules with the same DIP switch setting nothing will happen. However both those modules will have same buttons number and due this same functionality.
-  Keypad module does not need any setting
-  When you connect 2 keypads into system then both will work the same way.

1.7 Keypad VBDKey connection

Keypad module is connected by the same flat cable as button modules VBD10(5)-mod.

Connection to basic module is provide by flat cables K1. (1) is connection to basic module, (2) is connection of following button module

The connector (7) is not used at version analog A-VarioBell .

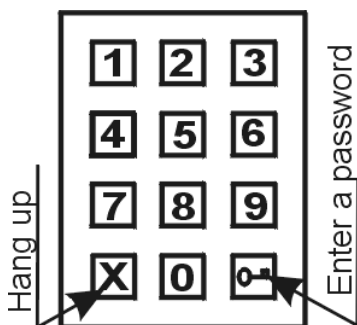
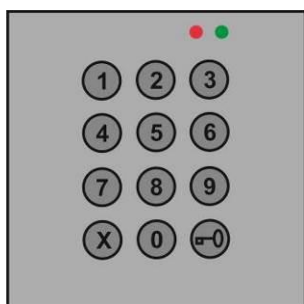
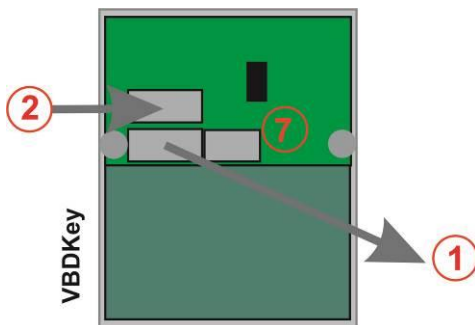



Dial is perform by progressive pressing of number buttons. To insert password for door opening you have to press first button with key symbol . To hang up you press in any time button and door phone hang up or cancel process of button dialling .

Code keylock you can insert either from keypad after dial symbol or by pressing of button combination from first 10 buttons (buttons 1- 10, when button 10 = in code 0)

The keypad has 2 basic modes of operation (parameter 49).

- Direct numbers dialling – on the keypad you dial numbers like on the phone (max. 24 characters)
- Dial from door phone memory – you dial just 2digit number on keypad = memory address (01- 99). This mode save connected buttons. For more subscribers is more suitable use a few buttons of direct dialling and keypad in mode of memory dialling than use many buttons modules.

Note: button 1 on basic module address the same memory of phone numbers as keypad dial 01 – in door phone is 99 memories only for DAY mode and 99 memories for NIGHT mode. The keypad use the same memories as buttons!

During call is possible setup by parameter **40** DTMF dialling possibility. Therefore button  is used on keypad strictly for hang up and function cancel, then dial * / # is possible setup under button  just by value of parameter 40.



Keypad module does not need any setting



When you connect 2 keypads into system then both will work the same way.

1.8 Basic module signalling on front panel

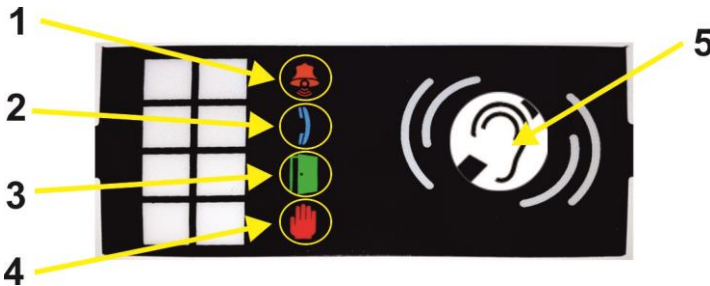

A-VarioBell mechanical front panel allows in basic module window LED signalling of door phone status. This signalling follows the requirement of handicap law.

- Bell symbol **(1)** yellow LED lights in time when door phone is ringing or establish / cancel the connection (establish connection).
- Phone symbol **(2)** blue LED lights in time when call is picked up and you speak (call).
- Door symbol **(3)** green LED lights during activation of relay (s) (Door opening).
- Hand symbol **(4)** red LED lights during door phone operation (line OFFHOOK).
- In programming mode by phone flashing alternately LED **(1)** and **(2)** and lights red LED **(4)**
- In PC programming mode lights LED **(2)** and **(4)**.
- Hearing impaired friendly system – optional audio-induction loop **(5)** for speaker



Caution: Those signalling are available with 12V power supply only !

2 Installation

2.1 Mounting

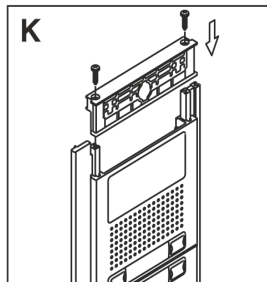
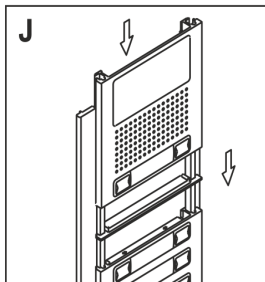
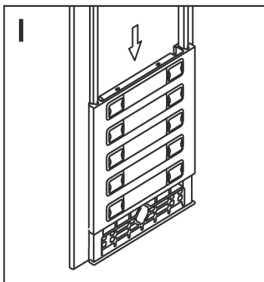
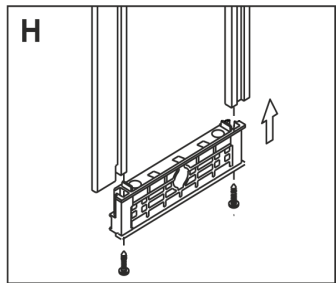
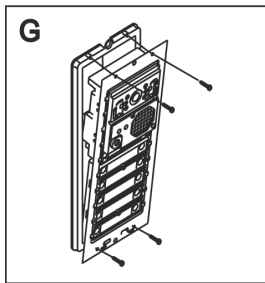
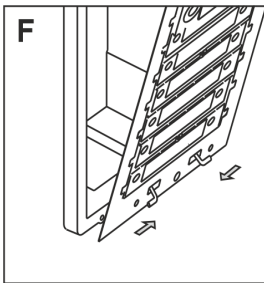
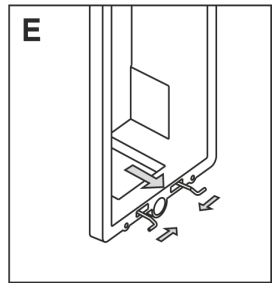
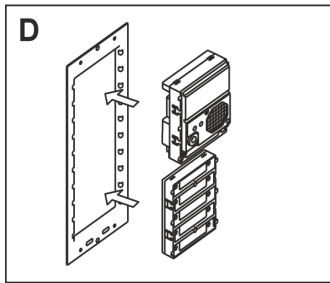
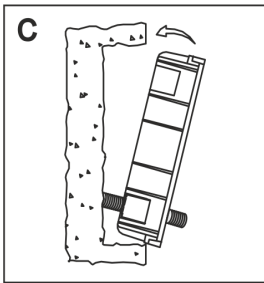
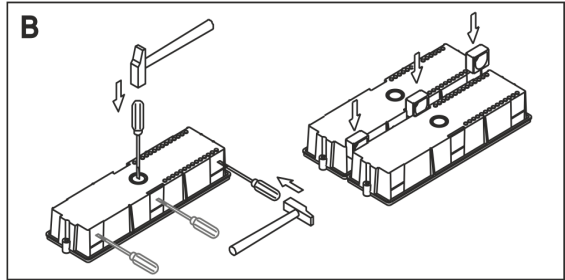
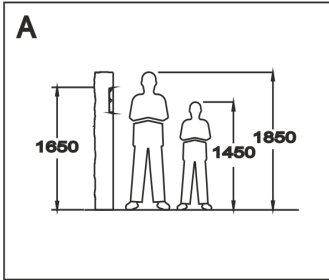

Mounting process:

- A. Preparation of mounting holes in the wall – recommended height is about 160cm from ground. Dimension of holes depends on number of modules and here we mention dimensions for 1,2 and 3 modules (basic mounting boxes). The bigger sets are completed from those boxes by their combination (under or next each other).

Modules	1	2	3
height mm	140	257	374
width mm	125	125	125
depth mm	56	56	56

- B. Preparation of mounting box for cable and mutual connection of mounting boxes
- C. Mounting box fixing into hole in the wall
- D. Inserting of each modules into into fixing frame
- E. Inserting of spring to bottom part of mounting box
- F. Inserting of fixing frame into spring in mounting box
- G. Installing of fixing frame to mounting box by 4 screws (supplied)
- H. Completing of design frame – firstly screw up side rails with bottom part
- I. Into design frame insert front panels of each modules
- J. Last module (module on top) is slide into design frame
- K. At the end screw up top part of design frame into side rails
- L. This complete as set is on picture (H+I+J+K) for further set into next mounting box
- M. Last step is put covers on design frame

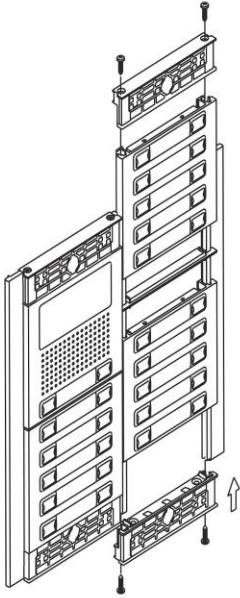
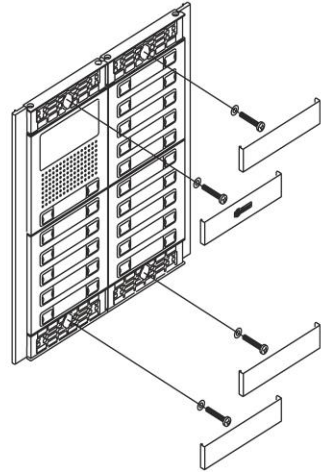
L**M**

2.2 Connection

Basic function (call establishing and hang up) requires connection of **phone line** only- **LINE (9)** on Picture 1. The line is connected by 2 wires (a,b) and in stand by has voltage 24V - 60V, short circuit current 20mA - 60mA. When line is OFFHOOK the voltage is 7V - 10V.

Line connection A-VarioBell door phone announce by sound signal (Reset) 🎵 (capture **Chyba! Nenalezen zdroj odkazů.** page **Chyba! Záložka není definována.**) when is disconnected from line certained time. A-VarioBell is analog door phone designed for connection to analog phone line. It means line where working standard analog phone. The door phone works regardless polarity of phone line and in range of values mentioned in technical parameters (capture 0).

Paralell connection – is not recommended!!! Parallel connection with other phone or door phone is not recommended due problems during operation. It is also not recommended used different devices switching the line (line splitter etc..).

For board heating, name cards lighting, powering of current loop of exit button and relays control is neccessary connect **12V power supplyj (6)** on Picture 1. The PSU might be AC or DC and not depends on polarity . From 12V is max. consumption 250mA. Power supply is possible use also for electrical lock powering then is recommended 12V/1A AC. During installation to already installed for example access system or sliding doors can occurs opportunity use already installed PSU and then is possible use 24V DC but , **not! AC**, not depends on polarity.

Relays (7) on Picture 1 have many ways of usage and examples of connection are on picture 5 . for correct operation must be connect 12V. The door phone is designed with all important parts galvanically isolated. The phone line is isolated from power supply as same as relays contacts are isolated from other door phone parts.



You must not switch direct main voltage 120V or 230V in any case!!! The control electrical appliance you have to use contactor picture 5 example (6)

Examples of relays connection are mentioned on following page. It is not all possibilities but it shows how to connect individual circuits (red circles with numbers = example number).

1. Basic connection - 2 electrical locks and possibility control 2 doors independently (relay mode 1 and 2 m=1) or progressive door opening (relay mode 2) - m=5.
2. 2 power supply – possibility to use independently 2x Power supply. One for A-VarioBell and second for electrical locks. Electrical lock 2 is connected inversally (fire emergency door).
3. Combination of doors electrical lock and sliding gate (fence).
4. Extending of previous example for 2 doors with progressive opening (this feature is setup in TimeRelay - option modul)
5. Combination of electrical lock and external bell. External bell contact might be in mode m=4 (it will close for preset time from each button) or in mode m=6 (it will close for preset time from one preset button)
6. Lighting activating m=3 (for example way to building) by relay 1. The relay 2 – control for example heating according mode DAY/NIGHT m=8. It requires external power supply (DIP 3 and 4 + par.64=1),further is necessary use contactor (A-VarioBell **must not activate** 230V!).

Examples on picture are principal.



Note: A-VarioBell door phone is designed to allows connect to screws 12V voltage 10-18V AC or 11-24V DC (not depends on polarity). Board heating is equipped by regulator to protect resistors demaging by higher voltage.

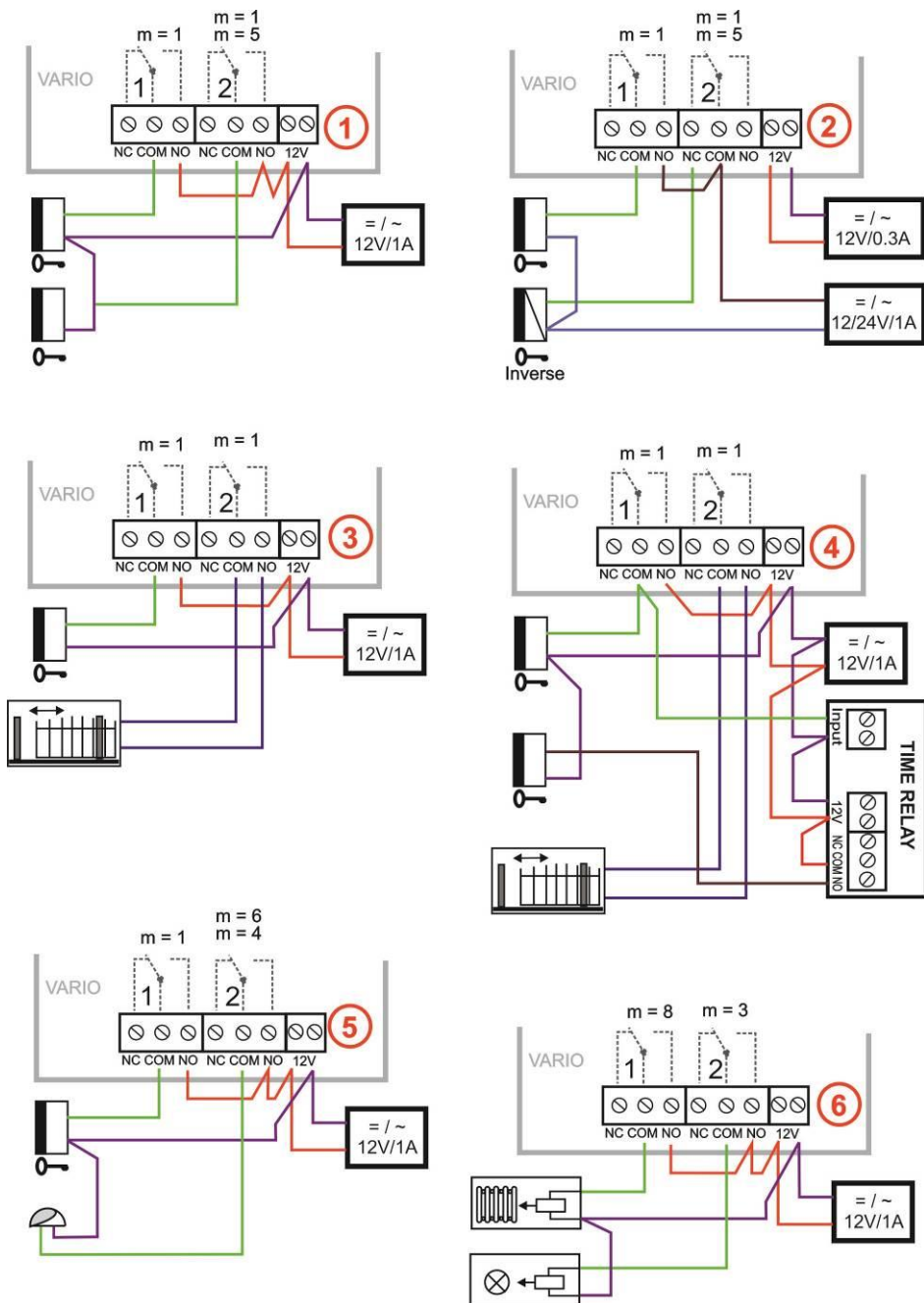

picture 5: examples of relays connection

2.2.1 Code relay (COSW)

For the first switch is available function code relay (COSW CodeSwitch). It serves primarily to secure transmission of information by switching the electric lock. When using this function is not possible connecting or disconnecting the voltage at the terminals to lock this lock activated. Activation is performed only when positive result compared serial information transmitted between A-VarioBell and the board code relay.

The A-VarioBell is set in several codes to activate the relay code. Relay can be activated codes for one or two impulses can differentiate activated from the phone (DTMF) or from keys (keypad). The last option is the activation code in another mode switch than the lock.

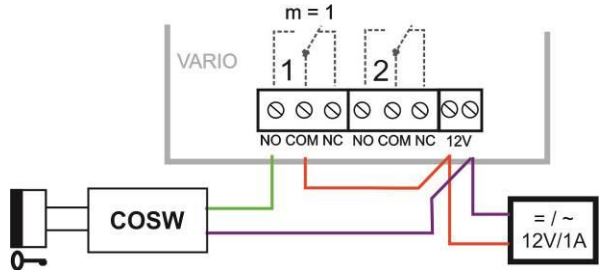

The code information is 8 bits, but the code is 4 bits with security 4 bits which is total of 8 bits. Practically, this is performed so that after activation the switch is first transmits the serial code, and if they agree, so code relay connects the electric lock.

! The code relays can be connected in parallel to increase the number of switches, but can never combine connections electric lock and the code relay parallel!

2.3 Further options

2.3.1 TimeRelay

The time relay enables wider functionality of the relays. It is a separate product and detailed instructions can be found at www.alphatechtechnologies.cz

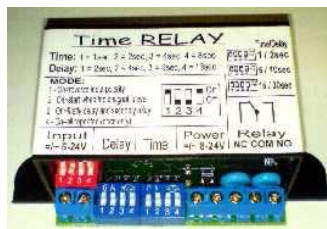

2.3.2 Power supply 12V

12V/A alternative power supply is recommended for the A-VarioBell. This is not a part of delivery and must be ordered separately. Further details of power supplies and electric locks can be found at www.alphatechtechnologies.cz



2.3.3 USB programming cable

It is not supply in standard package. Must be ordered individually. Drivers USB you can download on www.alphatechtechnologies.cz















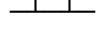

3 Door phone system operation

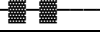
The A-VarioBell door phone system's functions are set by establishing parameters (see the chapter on parameter programming page).

3.1 Signalling overview

A-VarioBell acoustic signals that occur during its operation. Samples of sounds can be listened to in the setting programme A-VarioBellSet.

State	Tones	Tone frequency
Pick up line type 1		980-1333-1650
Disconnection of line type 1		1650-1333-980
Pick up line type 2		800-1067-1200-1333
Disconnection of line type 2		1333-1200-1067-800
Confirmation of command from the phone		800
Ticking during a call		
Notice about the end of a call		1333
Relay switch signal		Modulated
Entry into programming from the phone		980-1067-1180
Programming from the phone		Modulated
Parameter confirmation		800
Entry into programming from the PC		980-1067-1180
Line connection (Reset)		1850-1067-1850
Error (generally something is not right)		800
Empty memory (no number is programmed)		1300-2100

It is useful to know what tones the A-VarioBell Steel plays during installation as it will assist in the analysis of its state and operation. The sounds can be turned off in several levels (*parameters 61,62,63 and 65*). To play and listen to the sound signals, click on this [link](#).

3.2 Visitor at the door

The door phone buttons are labelled in the same way as normal doorbell buttons. Visitor finds the appropriate name (for example Mr.Horacek) and presses the button. The A-VarioBell will pick up a line, "plays" the pick up line tone (if it is not prohibited *par.62*) and dials the phone number saved under that button (*parameter 1 or 2* depending on door phone mode). From A-VarioBell speaker a ringing tone will be heard and Mr.Horecek's phone will ring. As soon as Mr Horacek picks up he can talk to his visitor. If an electric lock is also connected to the A-VarioBell, Mr Horacek can press a DTMF code on his phone and let visitor in. If he puts down the phone the A-VarioBell will disconnect. If the call takes longer time than the pre-set limit (*parameter 52*), 10sec before disconnection the A-VarioBell will send a line disconnection tone, but Mr Horacek can dial * or # (*parameter 42*), to prolonged the call for the length of time set in *parameter 52*.

The dialled number depends on the dial mode, which is set in the door phone (*parameter 47*):

- **DAY/NIGHT mode** = if the system is in 'Day' mode, it dials the number set in *parameter 1*, if the system is in 'Night' mode, it dials a number set in *parameter 2*. The switching over of modes manually is set in *parameters 45,46*. It is possible to activate Day/Night modes automatically and numbers dialled are selected according to a time in the table (*parameters 00-06*).
- **2 groups mode** of numbers = the first press of the button always dials a number set in parameter 1. Following the repeated pressing of the same button, when it detects a busy tone (10sec after choice), or after a pre-set number of rings (*parameter 56*) the door phone dials a number from the second group (*parameter 2*). After another press of the same button the system will again dial the number from the first group (or after detecting a busy tone on the dialling of a number from the group 2 the repetition ends).







If a visitor presses the button after the system has picked up, the system will disconnect for a length of time as set in *parameter 54* before it picks up the line and dials a new number. The number choice takes place either by tone (DTMF) or impulse according to the setting in *parameter 41*. There is one more option, disconnection of line after repeat pressing of the same button (*parameter 4**).

It is possible to control a relay switch (**code lock**) with the first 10 buttons. If visitor at the door presses buttons in the correct combination according to a pre-programmed code (*parameter 32-34*) and the length of time between presses isn't greater than the pre-set time (*parameter 53*) the system picks up, switches the appropriate relay (if it is set in mode $m=1$ or $m=5$) for the length of time given in *parameter 37 or 39,30* and then disconnects.

Relays can switch on one or two impulses depending on control code with the length of time between impulses set in *parameter 30*. viaTab. 1.

3.2.1 Relays modes

mode m = 1 (parameter 3111 and 3121)			
Action	Note	Parameter	Relay
Evaluation of correct internal code from the buttons	According to setting Day/Night	3211-3215	
		3311-3315	
		3411-3415	
	According to setting Day/Night	3221-3225	
		3321-3325	
		3421-3425	
	According to setting Day/Night	321*	
331*			
According to setting Day/Night	341*		
	322*		
According to setting Day/Night	332*		
	342*		
Internal code from the phone	Option to choose 1 or 2 digits of code 2 digit code is basic and it is possible to shorten it by using * in the first place of code during programming	351	
		352	
		361	
		362	
mode m = 5 (parameter 3125)			
Action	Note	Parameter	Relay
Evaluation of correct internal code from the buttons	According to setting Day/Night	3211-3215	
		3311-3315	
		3411-3415	
	According to setting Day/Night	3221-3225	
		3321-3325	
		3421-3425	
	According to setting Day/Night	321*	
331*			
According to setting Day/Night	341*		
	322*		
According to setting Day/Night	332*		
	342*		
Internal code from the phone	Option to choose 1 or 2 digits of code 2 digit code is basic and it is possible to shorten it by using * in the first place of code during programming	351	
		352	
		361	
		362	

mode m = 4			
Action	Note	Parameter	Relay
Press buttons	Any number other than in 311* or 312*	3114	
		3124	
	Button set in 311* or 312*	3114	
		3124	
mode m = 6			
Action	Note	Parameter	Relay
Press of the button	Any number other than in 311* or 312*	3116	-
		3126	-
	Button set in 311* or 312*	3116	
		3126	

Note t1 – time of connection of relay 1 (*parameter 371*)
t2 – time between impulses of relay 1 (*parameter 301*)
t3 – time between connections of relay 1 and 2 (*parameter 39*)
t4 - time of connection of relay 2 (*parameter 372*)
t5 - time between impulses of relay 2 (*parameter 302*)

Tab. 1 Relays control table

3.3 Person inside building

The person in the building means the person who is in telephone contact with the A-VarioBell door phone (Mr.Horacek).

3.3.1 Outgoing call

An outgoing call is a call from the A-VarioBell door phone (i.e. started by a visitor). Once the system has been dialled, a phone inside of the building rings and on pick up it is possible to talk to the visitor at the door. By choosing a code it is possible to switch on a relay (*parameter 35*) if it is set in mode m=1 or m=5, switch over the Day/Night mode (*parameter 45, 46*) and disconnect the connection (*parameter 43*). 10sec before the end of the call (*parameter 52*) the system sends a notice about the end of the call but choosing a code (*parameter 42*) it is possible to pro-long the call. By replacing the handset the call is terminated (the switchboard phone will send a system busy tone and the system will disconnect). There is one more option, disconnection of line after repeat pressing of the same button (*parameter 4**).

3.3.2 Incoming call

An incoming call is a call to the system (started by a person inside the building). After choosing the branch the system is connected and the line rings, following a set number of rings (*parameter 51*) the system will then pick up and it is possible to speak. The options are the same as an 'outgoing call' (chapter 3.3.1)



- One exception is in the first 10sec. when it is also possible to input '# and a service password' (*parameter 44*) directing the system to go to the programming regime.
- Another exception is during incoming call and DIP1 is switched to on ("SERVIS") when the system also goes to the programming regime (without a service password).
- The final exception is relay controls (*parameter 381 a 382*), when an incoming call can disable the relay controls.

3.3.3 Door phone with keypad – module VBDKey

Keypad module is detected automatically however for correct operation is necessary setup following parameters:

- **parameter 49** – keypad mode. .
 - If it is 0, then the phone number from the keypad is dialled in the same way as from a phone. The visitor enters a number combination and after a length of time, set by the max time between key presses (*parameter 53*), the A-VarioBell picks up and dials the given number.
 - If 1 then the keypad choses a 2 digit combination 01-99 as per the memory address, where a telephone number is saved. The memory is the same (shared) as the button memory. The number choice depends on the Day/Night setting.
- **parameter 40** – choses the DTMF from the keypad during a call.

Parameter value 40	Meaning of symbol 
0	No DTMF from the keypad
1	DTMF *
2	DTMF #
3	DTMF A

The keypad has 2 functioning keys – **key symbol**  = after pressing a number combination can be inputted to control relays. Second key – **symbol X**  = after pressing the system always disconnects.

Dialling number on the keypad can be done in two ways (*parameter 49*):

- visitor dials keys like on a phone – the length of time between the presses must be less than the time given in *parameter 53*, after this the system picks up and dials the given number.
- Visitor dials a 2 digit number (from 01 to 99), which represents a memory number where a number is saved (max. 24 digits long) as per the buttons. The number choice is dependent on the regime setting (i.e. Day/Night) or by regime 2 groups of numbers (as is described in chapter 1.7).

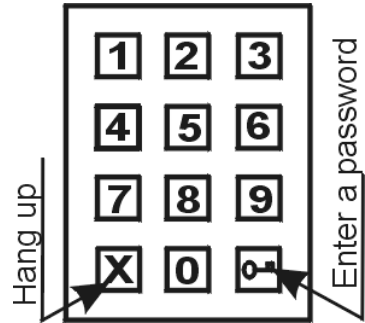

3.4 Acoustic path setting

The principle of setting acoustic paths:

Here we have three parameters 71,72 and 73 Using the interaction of these parameters can be set to sound in different conditions.

1. quiet environment parameters 71,72,73 are set to 7
2. environment where is a strong ambient noise at the communicator and quiet environment at the phone. Here is both necessary to reduce the microphone gain (parameter 72 = 1-3) and also change the ratio of the parameters 71/73 way 73 enlarge the the parameter (parameter 73 = 11-15) and 71 parameter smaller value (71 = 2-4)
3. environment where is a strong ambient noise at the phone and quiet environment at the communicator. Here we leave the parameter value of 72 = 7 and 73 and 71 parameters set as follows - parameter 71 = 11 to 14 and 73 = 2 to 4

The principle of settin parameters is - signal from the microphone is amplified by the sum of parameters **72+71 = volume of microphone** and signal to the speaker is amplified by the sum of parameters **71+73 = volume of speaker**. To switch the direction of the ratio is evaluated parameters (**threshold**) 73/72.

- If parameter 72 is greater than the parameter 73, thus favoring the direction from the microphone. We choose when the direction to the phone is interrupted.
- If parameter 73 greater than parameter 72, thus favored direction to the speaker. We choose this if the interrupted sound in the speaker of communicator.

4 Parameters programming

4.1 Programming by phone

4.1.1 Programming enter

A-VarioBell dveřní vrátný se uvede do režimu programování dvojitým způsobem:

1. **By password** – incoming calls only! – pick up a phone and dial the number that the A-VarioBell is connected to (*either the number of the branch, if you are connected to a switchboard line, or the number of the line to the building, where the A VarioBell is installed and ask to be connected to the extension where is A VarioBell connected*). The A-VarioBell will pick up (you will hear the pick-up tone – see chapter 9) within 10 secs. press '#xxxx', where xxxx is the service password to enter the programming (*in the basic setting xxxx=0000*) When password is correct there will be a programming entry tone followed immediately by a programming tone).
2. **By DIP 1** "SERVIS" – incoming call only! – connect to the A-VarioBell as in part 1 above, but where the DIP switch is in position 1 "on", the A-VarioBell will go directly to the programming mode – you will hear the pick-up tone for entry to programming followed immediately by the programming tone)

Do not forget to put DIP switch to position "off" at the end .

4.1.2 parameters programming

The default state for programming is announced with a programming tone, the A-VarioBell always returns to this state after a specified time (5sec), whether you started programming or not.

There are two types of parameters used during programming. These are parameters with a **fixed length**, which is the majority of them, when programming is confirmed after it fulfils the mandatory length and is immediately 'written in' with a **confirming tone** and parameters **with variable length** (*parameters 1,2,32,33,34*) when the **confirmation** is made only after time of inaction (5 sec). The only case when there is an immediate 'writing in' of parameters is when the maximum number of 'written in' signs (numbers) are filled up, for parameters *1 and 2* it is 24, for parameters *32,33,34* it is 6.

If you input a number (sign) that is unacceptable during the programming the A-VarioBell immediately sends an **error tone**, the parameter is not 'written in' and the A-VarioBell reverts to a default state where it is possible to either repeat the parameter programming or start programming a different parameter.

The A-VarioBell will automatically disconnect from the programming regime after a period of inaction, 30 sec. With each DTMF tone dialled the time will always resets to 30 sec. It is also possible to end the programming mode by choosing parameter 9.

Note. If you want to keep a connection opened during the programming (prolong the 30 sec time) regime (i.e. before a customer decides what else he wants to be set) then you can press * or #, the A-VarioBell immediately answers with an error tone but will prolong the time before disconnecting..

4.2 PC programming – program A-VarioBellSet

To program the A-VarioBell by PC you will need to use a special cable USB-KAB and SW program A-VarioBell Set. The A-VarioBell will also need to be connected to a telephone line or connected to an internal power supply 12V - DIP3 and 4.

Procedure:

- Connect the A-VarioBell to the line or it is possible to use external power supply 12V (DIP 3,4);
- Connect A-VarioBell to PC via USB cable. The A-VarioBell will pick up a line and within 3 seconds a tone for programming entry will be heard.
- Run programme A-VarioBellSet. Until the USB is disconnected the A-VarioBell is connected to the PC and it is in programming mode and do not run any other operations. If you loose connection, you will need to reconnect the USB cable – the A-VarioBell will then pick up.
- Connection between the A-VarioBell and the programme is indicated by the firmware on the bottom edge and a time on the upper left.

For ease of orientation the parameters in the A-VarioBellSet programme are marked with the same codes as per the phone programming.

The details about parameter setting can be found in 'help' of the programme and also on the manufacturer's website www.alphatechtechnologies.cz.

USB cable is special cable with galvanically isolated convertor to 3V. The galvanical isolation is a must because phone line must not be grounded and PC is usually grounded.

5 Adjustable parameters description

Parameters always start with a fixed/mandatory part (address) followed by a variable part, which is your choice. The range and explanation is always under the table, sometimes with examples. Everything is dialled exactly as it is shown in the table, nothing needs to be confirmed in any way, after writing into a memory a confirmation tone can be heard and if an incorrect value is input then an error tone will be heard.

5.1 Direct numbers dial – memories

Parameter	Value	Meaning	default
1	tt nn...	number nn under button tt	-

tt – button number (memory), always input 2 digits [01-99]

nn – telephone number as long as 24 digits that are to be saved. For saving of other sign choices always use the assignation as per the table.

Numbers saved in parameter 1 are numbers of the **first group**, or numbers of the regime **Day**.

Default settings never change or delete these saved numbers.

meaning	choice
0 - 9	0 - 9
#	#
*	**
Flash	* #
Pause	* 0

Parameter	Value	Meaning	Default
2	tt nn...	number nn under button tt	-

tt – button number (memory), always input 2 digits [01-99]

nn – telephone number as long as 24 digits that are to be saved. For saving of other sign choices always use the assignation as per the table.

Numbers saved in parameter 2 are numbers of the **second group**, or numbers of the regime **Night**.

Basic setting never change or delete these saved numbers.

meaning	choice
0 - 9	0 - 9
#	#
*	**
Flash	* #
Pause	* 0

Note. The Day/Night regime switch over remains set in the A-VarioBell even after a line disconnection. When you activate automatic switching DAY/NIGHT mode this mode is switching according actual time (if this function is on – parameter 084)

Examples of setting:

1. first button is supposed to dial 358 during the day and 0603441296 during the night, then the programming is - 101358 and wait for 🎵, then 2010 *0 603441296 and wait for 🎵

2. second button is supposed to dial 123#1*2Flash3 during day and night, then the programming is 102123#1 ** 2 *# 3 and wait for ♪, then 202123#1 ** 2 *# 3 and wait for ♪

Note. If you are not using mode Day/night or mode 2 groups of numbers, then it is recommended to set mode Day/Night (*parameter 47*) and then set the same code for switching over Day/Night (*parameters 45 and 46*). His way it is guaranteed that A-VarioBell will always be in Day mode and you can only programme telephone numbers for the day mode (*parameter 1*).

5.2 Relays

Parameter	Value	Meaning	Basic
31	r m	relay r operates in regime m (1-8)	11 21

r – relay number [1-2]

m – relay mode [1-8 for r=1 is not regime m=5]

modes **m=1, 4, 5, 6** are explained in detail in Relay modes Tab. 1 on page 31

m=1 mode **relay** – switched on with command (internal code) or with a password (external) 1 impulse for length of time t1/t4 (use for electric locks) or 2 impulses when it switches on for time t1/t4, off for t2/t5 and again switches on for t1/t4 (opening of sliding gates).

m=2 is switched on for time when the line is picked up (**camera**) – switches on when system picks up and off when it disconnects

m=3 is switched on for time when the line is picked up and extra time t1/t4 after disconnection (**lights**) - switches on for time when the line is picked up and extra time t1/t4 after disconnection (for this time the line is busy, after switching DIP 3, 4 and setting of *parameter 64* line after t1/t4 disconnected)

m=4 mode **button** – switched on when any button is pressed and off after t1/t4 (use is for example connection of external bell or siren)

m=5 mode **gradual opening** – into this mode it is possible to set only relay 2, because relay 1 will then automatically be set to m=1. With command (internal code) or password (external code) relay 1 is activated for length of time t1, then time t3 is running before relay 2 is switched, then relay 2 is activated for time t4 and after the system disconnects. If given command or password answers to 2 impulses then in the sequence there will be always 2 impulses separated by time t2/t5. Explanation is in Tab.1.

Note. Command or password for relay 1 starts the whole sequence, if you use command or password for relay 2 then only relay 2 is controlled in the same way as in mode m=1.

m=6 switches on depending on pressed button (it is set in parameter 31r*). In this way it is possible to choose only **one button** for each relay, which when pressed switches on relay for time t1/t4. This mode is used instead of connecting separate doorbell to the system.

m=7 permanent switch on / off – possible to use when switch DIP 3,4+param.64. With command for 1 impulse it is switched on, for impulse 2 is off. The system remembers its state even after the line is disconnected. This regime is used for watering, green house opening, switching on heating etc.

m=8 switching depends on setting Day/Night mode – for switching (DIP 3, 4+param64). Appropriate relay switching either according status DAY/NIGHT mode (by DTMF code) or when is activated automatic switching DAY/NIGHT mode it is possible activate relay according setting of switching times (automatically) from week table (when is ON - *parameter 084*) . Then is possible use it for example for Heating activation etc...

Parameter	Value	Meaning	default
31	r* tt	button tt switches on relay r in mode m=6 (01-99)	01

r – relay number [1-2]

tt – button number (memory), always in two digits [01-99]

This parameter is only for relay mode m=6. Value tt determines which button starts switching on for time t1/t4 of relay r.

Parameter	Value	Meaning	Default
32	rp hh...	In mode Day + Night password hh... for relay r, in order p=1-5 for 1 impulse and p=* for 2 impulses (00-999999)	-
33	rp hh...	In mode Day password hh... for relay r, in order p=1-5 for 1 impulse and p=* for 2 impulses (00-999999)	-
34	rp hh...	In mode Night password hh... for relay r, in order p=1-5 for 1 impulse and p=* for 2 impulses (00-999999)	-

r – relay number [1-2]

p – order [1 - 5] for 1 impulse. 5 passwords (external codes) from A-VarioBell's buttons (external code of code lock)

p – order = * to set password (external code) for 2 impulses

hh... – password (external code) for relay switching on from button or keyboard [2 to 6 places]. Buttons 1 - 10 are programmed as numbers 1-0.

All together 3x12 passwords, depending on the Day/Night setting, combinations are be input either with the help of the buttons (first 10) or from the connected keyboard (after pressing the key sign). Switching on a relay is affected by the relay **regime** and the choice **Day/Night**, if the mode **2 groups of numbers** is set, the system is constantly in mode **DAY**.

There are several rules that needs to be followed when setting a password

- Choose the first button of password from buttons that are the least used for direct dialling (-prolonging time) (n/a for keyboard).
- Be mindful about conformity of numbers (i.e. when 1 password contains another for example for relay 1 it is 1234 and for relay 2 12345) as the first password will start the action once button 4 is pressed and you will never be able to input button 5 to start action for password 2, and if you choose 234 for a second relay, then after pressing 4 both relays will start.

Note. When setting parameter **32,33,34** signs # and * are not used because they are not on the button panel, number 0 represents button no. 10.

Parameter	Value	Meaning	Default
35	r aa	command aa from phone for switching relay r 1 impulse (00-99,*0-*9)	155 266

r – relay number [1-2]

aa – command (internal code) for switching on the relay from the phone [2 spaces] /¹

To set the same commands for both relays (internal code) so that both relays activate at the same time. It is also recommended that the same command is set for 'relay on' and 'command to disconnection of system (*parameter 43*) **aa=bb**.

¹ – command is always 2 digits, but if you wish to control relay with a single digit from the phone, there is an option to input "***a**", where **a** is a single number and the star represents an empty space and must be in the first place.

Example:

1 relay switch on internal code 48 – is programmed **35148** 🎵

2 relay switch on internal code 8 - is programmed **352*8** 🎵

By choosing no 8 on the phone we switch on just the second relay, with option 48 we switch on both relays

Parameter	Value	Meaning	Default
36	r cc	command aa from phone for switching relay r 2 impulses (00-99,*0-*9)	150 260

r – relay number [1-2]

cc – command (internal code) for switching on the relay from the phone [2 spaces] /¹

To set the same command for both relays (internal code) so that both relays activate at the same time

¹ – command is always 2 digits, but if you wish to control relay with a single digit from the phone, there is an option to input "***a**", where **a** is a single number and the star represents an empty space and must be in the first place.

Switching a relay on with 2-impulses is used for sliding gates replacing a gate entry.

Example:

Command for switching on 2 relays 1 impulse is for example *8, the command for disconnection is *8 and the command for switching on 2 relays 2 impulses is *9.

Programming: 352*8 ♪ , 432*8 ♪ , 362*9 ♪.

If you are in conversation with the A-VarioBell, the command to open a gate would be button 9, the first impulse starts and the gate opens, the second impulse stops it, the time the gate is opened "opened space" is set by time between the impulses (*parameter 30*) after people enter press 8, then A-VarioBell makes 1 impulse and disconnects, gate closes.

Parameter	Value	Meaning	default
37	r ss	time ss [sec] of relay r on for time t1/t4 (01-99)	105 205

r – relay number [1-2]

ss – time t1 / t4 for which relay 1 / 2 is switched on [2 spaces 00-99], where time 00 means 0,5sec

Parameter	Value	Meaning	default
38	r p	relay r control during incoming call (0/1)	11 21

r – relay number [1-2]

p – parameter whether it is allowed p=1 or disallowed p=0 to control relay during incoming call.

To prohibit 'control' during an incoming call, for use with relay 2 in mode 1 for controlling a garage door, so the electronics open the garage door and the car passing through the door, closes the door. Then control from the phone could result in a permanently opened door (i.e. the door doesn't close because car didn't enter).

Parameter	Value	Meaning	default
39	xx	time xx [sec] between switching on relays 1 and 2 in regime m=5 - time t3 (01-99)	10

xx – time t3 between switching on relays 1 and 2 when regime m=5 is set (gradual opening) [2 spaces 00-99] , where time 00 means 0,5sec

Parameter	Value	Meaning	default
30	r zz	time zz [sec] between impulses for switching on relay r 2 impulses- time t2/t5 (01-99)	105 205

r – relay number [1-2]

zz – time t2 / t5 between first and second impulse for switching on relay 1 / 2 [2 spaces 00-99], where time 00 means 0,5sec

Parameter	Value	Meaning	default
3*	r e	Exit button for relay r (0/1/2)	10 20

r – relay number [1-2]

e – exit button mode: **e=0** - off, **e=1** – on for 1 impulse, **e=2** – on for 2 impulses

Rameter	Value	Description	Default
3#0	p	p = 1 enabled / disabled p = 0 connection code relay COSW (0/1)	0

p – turns on transmission serial code to activate the first switch.

CAUTION - at activation this function never connect to the circuit electric lock without board COSW - code relay - threatens to destroy the relay in A-VarioBell door phone!

The following codes may be the same or different for the resolution switching on multiple parallel connected relay code.

Rameter	Value	Description	Default
3#1	abcd	activation code 1 pulse from buttons (0000-1111)	0000

abcd – A-VarioBell sends a serial code for the code relay (COSW) after evaluation code from keys (keypad) namely for 1 pulse

Rameter	Value	Description	Default
3#2	abcd	activation code 1 pulse from phone (0000-1111)	0000

abcd – A-VarioBell sends a serial code for the code relay (COSW) after evaluation code from telephone (DTMF) namely for 1 pulse

Rameter	Value	Description	Default
3#3	abcd	activation code 2 pulses from buttons (0000-1111)	0000

abcd – A-VarioBell sends a serial code for the code relay (COSW) after evaluation code from keys (keyboard) namely for 2 pulses

Rameter	Value	Description	Default
3#4	abcd	activation code 2 pulses from phone (0000-1111)	0000

abcd – A-VarioBell sends a serial code for the code relay (COSW) after evaluation code from telephone (DTMF) namely for 2 pulses

Rameter	Value	Description	Default
3#5	abcd	activation code from other modes of switch (0000-1111)	0000

abcd – A-VarioBell sends a serial code for the code relay (COSW) after evaluation code from other modes m switch 1

5.3 Basic parameters

Parameter	Value	Meaning	Default
41	v	Type of choice v – time/impulse (0/1)	0

v – type of choice v=0 is DTMF tone choice, v=1 is impulse choice

Parameter	Value	Meaning	Default
42	z	Sign for call prolonging (* / #)	*

z – sign for prolonging a call * or # (10secs. before the end of the call the A-VarioBell sends signal, after pressing this the A-VarioBell prolongs the call)

Parameter	Value	Meaning	Default
43	g bb	Command for disconnecting A-VarioBell from the phone (00-99,*0-*9)	155 266

g – Command order [1-2] (there are 2 to disconnect the A-VarioBell from both relays)

bb – Command for disconnecting the A-VarioBell from the phone [2 spaces]
/1 It is advantageous to set the same command for relay switching on (parameter 35,36) and command for the A-VarioBell disconnection aa=bb or aa=cc.

/1 – command is always 2 digits, but if you wish to control relay with a single digit from the phone, there is an option to input "*a", where a is a single number and the star represents an empty space and must be in the first place (e.g. at parameters 35,36).

Parameter	Value	Meaning	Default
44	xxxx	Service password (0000-9999)	0000

xxxx – service password to programme from a phone (DTMF)



If you forget the password, the following procedure is recommended:

1. Open the A-VarioBell front cover;
2. Switch 'DIP 1' to 'ON';
3. Call the A-VarioBell;

4. Once the A-VarioBell picks up the system is in programming mode. In this mode it is possible to change the password 44xxxx;
5. Switch 'DIP 1' to 'OFF'; and
6. Close the front cover.

Parameter	Value	Meaning	Default
45	dd	Command for switch over to DAY (00-99,*0-*9)	11
46	nn	Command for switchover to NIGHT (0099,*0-*9)	10

Dd command to switch over to the **DAY** mode [2 spaces] /¹

Nn command to switch over to the **NIGHT** mode [2 spaces] /¹

/¹ command is always 2 digits, but if you wish to switch over from Day to Night with a single digit from the phone, there is an option to input "*a", where **a** is a single number and the star represents an empty space and must be in the first place (e.g. parameters 35,36)

Note. The Day/Night mode stays even after line disconnection.

Parameter	Value	Meaning	Default
47	e	Mode of door phone dial (0/1)	1

e – Choice of mode numbers; **e=0** selects numbers from first and second group, **e=1** selects numbers in accordance with the **Day/Night** mode.

 **WARNING !!** setting this parameter materially affects the number dialling!

Parameter	Value	Meaning	Default
49	o	Regime keyboard (0/1)	0

o – **o=0** dial a number like a phone (input the whole number)

o=1 input a 2 digit number (memory) on the keyboard, where the number is saved into the memory (the memory number is the same as button number and respects Day/Night switch over – numbers 01 - 99)

 **WARNING !!** setting this parameter materially affects keyboard function!

Parameter	Value	Meaning	Basic
40	d	DTMF dial from the keypad during a call (0-3)	0

- d** – **d=0** during a call it is **not** possible to dial DTMF from the keypad
d=1 DTMF can be dialled, the Key button dials *
d=2 DTMF can be dialled, the Key button dials #
d=3 DTMF can be dialled, the Key button dials A

Parameter	Value	Meaning	Basic
4*	k	Line disconnection function by repeatedly pressing a button (0/1)	1

- k** – Line disconnection by repeated pressing of the same number:
k=0 function is disabled; and
k=1 repeatedly pressing the same button to disconnect the line.

 **WARNING !!** setting of this parameter materially affects number dialling!

5.4 Time parameters

Parameter	Value	Meaning	Default
51	q	Number of rings before the A-VarioBell picks up (1-9)	2

q – The number of rings before an incoming call is picked up. The A-VarioBell picks up between rings 2 secs. after detecting the **q**-th ring. It is possible to set the number of rings between 1 and 9.

Parameter	Value	Meaning	Default
52	d	Maximum length of a call (0-9,*,#)	2

d – The maximum length of time for which the A-VarioBell is busy. It is possible to prolong this time during the call by choosing a key (* or #) from the phone (*parameter 42*). The setting of this time is in accordance with the adjacent table.

Time [min]	Option
0,5	0
1 - 9	1 - 9
15	*
30	#

Parameter	Value	Meaning	Default
53	w	Time between button presses (1-9)	2

w – maximum time [in seconds] between button presses [range 1 - 9]

- **Normal buttons**
 - **Relay switch on** – if the time between presses is longer than time **w**, then the code will not work correctly.
 - **Choice of number** – if the pressed button is the first number of a password to switch on a relay then the choice is delayed by time **w**.
- **Keypad**
 - **Switch on Relay** – if the time between presses is longer than the time **w** then the code will not work correctly.
 - **Number dialling**
 - Choose from the phone, if the time after the last pressed button is longer than time **w**, then the choice commences, if the number is incomplete, it is necessary to disconnect (press the **X** key ) and repeat the choice;
 - Choose from the memory, if the time after the last pressed button is longer than the time **w**, then the choice needs to be repeated.

Parameter	Value	Meaning	Default
54	z	Time of disconnection for repeat dialling (1-5)	2

z – Time [secs.] the A-VarioBell disconnects before it picks up again for repeat dialling (press of a button during a call, detection of busy tone) [range 1-5].

Parameter	Value	Meaning	Default
55	z	Time before commencing a choice (1-5)	1

z – Time [sec] after the A-VarioBell picks up, before it commences a choice [range 1-5]. This time is different for each switchboard phone system, but generally most operate within 2 seconds after a line is picked up.

Parameter	Value	Meaning	Default
56	hh	Number of rings before it disconnects (04-99)	12

h After the choice finishes it will start counting CRT (control ringing tones), if the number is higher than **hh**, then it will disconnect [range 04-99]. It repeats the choice if the mode of dialling 2 groups of numbers is set.

Parameter	Value	Meaning	Default
500	x	Medium frequency of tone detector (1-0)	3 (375-475Hz)
501	y	Number of busy tones (2-0)	4
502	z	Time length of permanent tone (1-5)	3 (3s)

- x** Medium frequency of tone detector is set if there is a non-standard signal from the telephone switchboard.
- y** Minimum number of busy tones necessary for detection [2-0], where 0 means 10 busy tones.
- z** Minimum length of time of a permanent tone (for detection of notification tone at branch switchboard) [1-5 sec].

Parameter	Value	Meaning	Default
503	tt	Tone length of time for DTMF (tone) choice (04-16)	10 (100ms)
504	mm	Time of gap between DTMF tones (04-16)	10 (100ms)
505	f	Length of flash time (1-6)	1 (100ms)
506	p	Length of time of pause/digit gap (1-0)	4 (800ms)

- tt** Length of DTFM tone choices is specified by the formulae:
(the entered number) x 10 = time length of tone [ms]
 [range 04-16 which is 40-160ms]
- m** Length of gap between DTMF tone choices is specified by the formulae:
(the entered number) x 10 = time length of gap [ms]
 [range 04-16 which is 40-160ms]
- f** Length of flash is specified by the formulae:
the entered number x 100 = time length Flash [ms]
 [range 1-6 which is 100-600ms]
- p** Length of pause is specified by the formulae:
the entered number x 100 + 400 = time length of pause [ms]
 [range 1-0 which is 500-1400ms]
- Time **p** is the simultaneously length of gap between button taps for an impulse dial.

frequency [Hz]	x - choice
275-375	1
325-425	2
375-475	3
425-525	4
475-575	5
525-625	6
575-675	7
625-725	8
675-775	9

507	uu	Transmit level of DTMF choice v [-dBm] (04-16)	10
------------	-----------	---	----

uu Transmission level of (DTMF) choice to the line, the range is -4 to -16dBm, input the required level where uu=04 is -4dBm, uu=10 is -10dBm

Parameter	Value	Meaning	Basic
508	p	preemphasis DTMF (0/1)	0
509	S	Listening in DTMF – level (1-4)	2

p Preemphasis is the ratio of the upper and lower groups of DTMF frequencies. It is possible to choose ratio 2.2 dB - p=0 (Europe) or ratio 3.2dB - p=1 (Australia)

s Choice of **DTMF** volume levels (4 levels):

Volume in DTMF [dB]	s - choice
-15	1
-9	2
-3	3
+3	4

5.5 System parameters

Parameter	Value	Meaning	Default
61	z	Acoustic signals (confirmation, error, empty memory, end of call) (0/1)	1

The A-VarioBell's comes with standard acoustic signals. However, using parameter "z" it is possible to switch off the acoustic signals. The values are:

z=0 Acoustic signals **off**; and

z=1 Acoustic signals **on**.

Parameter	Value	Meaning	Default
62	v	Acoustic signals introduction/conclusion (0/1/2)	1

The acoustic signals for the connection and disconnection of a line are standard, but this may cause false choices with some phone systems. So using parameter "v" it is possible to switch off these signals. The values required are:

z=0 Introduction/conclusion signalisation is off;

z=1 Pick up and disconnection signalisation on (intro/concl.- type1);

z=2 Pick up and disconnection signalisation on (intro/concl.- type2).

Parameter	Value	Meaning	Default
63	u	Acoustic ticking signal during a call (0/1)	0

Ticking during a call is switched off as standard. However, by switching it on you can differentiate on the switchboard a call from the A-VarioBell by a faint ticking.

The values are:

u=0 Ticking into a call is off

u=1 Ticking into a call is on

Parameter	Value	Meaning	Basic
64	w	Internal power supply from connected supply 12V (DIP 3,4) (0/1)	0

The external power supply is turned off as standard.

You only need to turn this function on if the A-VarioBell is supposed to operate functions when at rest (i.e. relay control). Relay in regime m=7 enables permanent switch-on even after call disconnection, regime m=8 enables switch-on depending on the Day/Nigh setting even after call disconnection. In these cases it is necessary to connect an internal power supply so that there is no current flowing through the A-VarioBell when the system is at rest.

Switching of this parameter **w=1** condition switching over DIP switch 3 and 4 to "on". Off - **w=0**.

Parameter	Value	Meaning	Default
65	z	Acoustic signals for switching on a relay (0/1)	0

The signal for switching on a relay is standard, **z=0**. However, it is possible to use this function when using a uni-directional supply 12V, so when the door lock is open there is **no** buzzing so the person at the door won't know the door is open. When set to **z=1** the time the relay is switched (door open) then there is a specific sound.

Note1 This function is available only for regimes **m=1** and **m=5**

Note2 During the relay switch-on (2 impulses) there is acoustic signal for the whole time of the sequence (even during gap between impulses).

Parameter	Value	Meaning	Default
66	i	Suppression of the reception DTMF from the microphone (0/1)	0

Suppression of the reception DTMF from the microphone is off as a default **i=0**. It is possible to open the door with a personal dialler without disturbing a person inside the building. For higher security it is possible to switch on the suppression function **i=1** and stop a person with an unauthorised copy of the DTMF code from entering.

Parameter	Value	Meaning	Default
67	b	Baby Call – call without the need to programme a telephone number (0/1)	0

This function is turned **off** as standard **b=0**. By switching on this function **b=1** the acoustic signal for an empty memory is cancelled, so after pressing a button with an empty memory there is only a beep (confirmation) and a call is activated as if there were a number.

Warning: During the first 10 seconds of a call the tone detector is inactive (there is a pause before the switchboard responds or number dialling by the switchboard).

Parameter	Value	Meaning	Basic
6#	s	Setting of the number of buttons on the main panel.	2

This constant serves a purpose to identify the no.1 button in the composition of the module. After entering the number of buttons **s** the button no 1 is moving so it is always first.

Number of buttons on the main panel	s - choice
0	0
1	1
2	2

 **WARNING !!** setting this parameter materially affects number dialling.

Parameter	Value	Meaning	Basic
6*	t	Delayed start for switchboards with line testing (Siemens) (0/1)	0

This function is off as standard **t=0**. By switching this function on **t=1** the processor goes into sleep mode immediately after the line connection, and after 3 secs. The A-VarioBell initialises. The line connection after the power supply connection is then delayed - state switching on/restarting of the switchboard. If this function is not working and the telephone switchboard still identifies a line fault, then there is no other option but to use an internal power supply, by switching over **DIP** switch **3** and **4** to "on" .

5.6 HandsFree parameters setting



First ensure that the rubber seal on the microphone fits properly, otherwise setting the acoustic parameters will be difficult.

Parameter	Value	Meaning	Basic
71	gg	Reception volume 01-16 (16 is the highest) (SPK)	07
72	ff	Transmission volume 01-16 (16 is the highest) (MIC)	07
73	rr	Speaker volume 01-16 (16 is the highest) (TRH)	07

gg/ff/rr Each number is entered as 2 digits with a range 01-16. After receiving a confirmation tone 🎵 the new value is immediately active and can be tested.

Facilitation: you can also add/reduce the volume with help of buttons on the phone * = - and # = +

Stops for the maximum and minimum volume are acoustically signalled (3 tones like the signal for the end of a call). If you don't press anything for 5 seconds then the 'set value' is saved and you hear a confirmation tone 🎵.

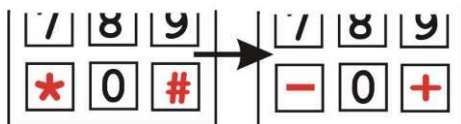

WARNING !! Default values are set by the manufacturer and it is not recommended that you change them unless absolutely necessary.

Parameter	Value	Meaning	Default
74	c	Soft transition of switch over (0/1)	1

This function is set to **off** as standard **c=0**, it is a character of the semi-duplex operation switch over on the telephone line. If the character of silencing is too steep, it is possible to soften it using **c=1**.

Parameter	Value	Meaning	Default
75	n	Suppression of background noise (0/1)	1

This function is set to **off** as standard **n=0**. If the A-VarioBell is installed in noisy location (train station, busy street, car park etc.) by switching on this circuit **n=1** the noise level is set as a default threshold for switching on the microphone and is not one way opened. This is related to setting of parameters 71, 76, 77.

Parameter	Value	Meaning	Default
76	b	Threshold for switching on the microphone 1-4 (4 is the highest)	2

There is a simultaneous signal from the microphone and the speaker on the telephone line, to ensure that the A-VarioBell doesn't produce acoustic feedback. In the Hands Free circuit there are several functioning blocks for suppressing this feedback. The basic one is a circuit for semi-duplex operation, where the incoming signal weakens the microphone and the signal from the microphone weakens the incoming signal. Thresholds for switching on the microphone are set in this parameter, the lower the value the higher the sensitivity of the microphone. In noisy surroundings it is recommended to use a higher value with combination of parameters 71,75, 77.

Parameter	Value	Meaning	Default
77	s	Speed of switching over voice atomisation 1-4 (4 is the slowest)	2

Parameters 75, 76 describes the principle of acoustic feedback and the speed with which the circuit switches over, the quality of incoming or outgoing sounds are set with parameter 77.

Switchover time [ms]	s - choice
1	1
2	2
4	3
8	4

Parameter	Value	Meaning	Default
78	I	VA characteristic for line connection (0/1)	1

Nearly every country in the world has different telephone norms and this parameter enables you to lower the voltage on the A-VarioBell's terminals to connect telephone line voltages in active state by 1V. Where it is required the respective norm **I=0** lowers line voltage by 1V, as standard it is **I=1**.

Parameter	Value	Meaning	Default
79	k	Compensation for loss of conduit depending on line current (0/1/2)	1

The A-VarioBell has a circuit for installations remote from the switchboard (>100m) that can compensate for the loss caused by a conduit. This function is switched **off** as standard **k=0**, but it is possible to set on 2 levels, depending on the current that switchboard can supply (short circuit current I_0).

Switchboard current I_0	k - choice
Function off	0
20mA-50mA	1
45mA-75mA	2

Parameter	Value	Meaning	Default
70	uu	Level of signal transmission v [-dBm] (04-16)	10

uu The signal transmission range to the line is -4 to -16dBm, entered is required level, which is uu=04 is -4dBm, uu=10 is -10dBm ...

5.7 Time programm - automatic day/night switching

Parameter	Value	Meaning	Default
09	a	Automatic on/off switch over for Day/Night and control of time setting (0/1/#)	0

The A-VarioBell has RTC circuit - it possible to switch on the automatic switch over time **a=1**. Condition is correct time setting. It is possible to make easy control **a=#**, the A-VarioBell answers either with confirmation tone (all is OK or with an error tone (it is necessary to set the time). Choice **a=0** switches off automatic switch over.



Parameter	Value	Meaning	Default
081	hhnn	Time setting hh-hours, nn-minutes	-
082	ddmm yyw	Date setting dd-day,mm-month,yy-year, w-day of the week	-
083	#	Waits 1 minute to reset to zero seconds	-

Setting of time parameters of internal clock. After setting it is possible to witch command **083#** zero sec and exactly reconcile clock to the sec.

w is number representing day of the week [0-6], where 0 is Sunday and 6 is Saturday

Day of the week	Sunday	Monday	Tuesday	Wednesday	Thursday	Friday	Saturday
w	0	1	2	3	4	5	6

Example: to set 27.5.2011 Friday 9:39, the sequence is:

0822705115 listen for tone , then 0810939 listen for tone  and finally 083 – wait for exact time sec=0, in this moment choose # and hear tone  - finished.

Parameter	Value	Meaning	default
00	hhnnkkjj	Sunday – time setting hours hh and minutes nn starts day and hours kk and minutes jj starts night	00000000
01	hhnnkkjj	Monday - time setting hours hh and minutes nn starts day and hours kk and minutes jj starts night	00000000
02	hhnnkkjj	Tuesday - time setting hours hh and minutes nn starts day and hours kk and minutes jj starts night	00000000
03	hhnnkkjj	Wednesday - time setting hours hh and minutes nn starts day and hours kk and minutes jj starts night	00000000
04	hhnnkkjj	Thursday - time setting hours hh and minutes nn starts day and hours kk and minutes jj starts night	00000000
05	hhnnkkjj	Friday - time setting hours hh and minutes nn starts day and hours kk and minutes jj starts night	00000000
06	hhnnkkjj	Saturday - time setting hours hh and minutes nn starts day and hours kk and minutes jj starts night	00000000
07	#	overwrites (copies) setting from Sunday (00) to the whole week	-

In parameters 00-06 automatic Day/Night switch over times are set for each day of the week. Parameter 07 is used when it is not necessary to programme the whole week if the times are the same, then it is enough to programme 00 (Sunday) and with parameter 07# this setting will be copied to the rest of the week.

Examples:

1. On Monday at 8:00 day starts, 17:05 night starts, Tuesday at 7:30 day starts and at 16:00 night starts

Programming sequence: 0108001705 and ♪, then 0207301600 and ♪

2. On Thursday day starts at 6:45 and night starts at 15:05, on Friday night continues till 15:00 when day starts and continues until Saturday 12:00 and then it is night again. Here it is possible to use setting in the frame of one day switching over day to the night even though the night is already on since the previous day and again to the day even though day is on from the previous day, then for time setting over midnight a time 00:00 is entered.

Programming sequence: 0406451505 and ♪, 0515000000 and ♪, 0600001200 and ♪

5.7 Basic setting and erasing

Parameter	Value	Meaning	default
8#	#	Basic setting	provide

This setting does not affect parameters 1 and 2 (numbers saved in memory)

Parameter	Value	Meaning	Basic
81		Deletes all numbers in 1st group (regime Day)	
82		Deletes all numbers in 2nd group (regime night)	
83		Basic setting only for parameters 3x	only 3..
84		Basic setting only for parameters 4x	only 4..
85		Basic setting only for parameters 5x	only 5..
86		Basic setting only for parameters 6x	only 6..
87		Basic setting only for parameters 7x	only 7..
80		Basic setting only for parameters 0x	only 0..

Parameters 81 and 82 deletes all numbers saved in the button memory.

Parameters 83 – 87,80 deletes selective basic setting for parameters starting with 3,4,5,6,7,0. Values for the basic setting are stated for each parameter in the right hand - column "Basic".

 **WARNING !!!** deletion is irreversible and it would be necessary to reprogramme them again!

5.8 End of programming

Parameter	Value	Meaning	default
9		E N D of programming	

After choosing 9 programming tone the A-VarioBell disconnects.

5.9 Parameters overview

Parameter	Value	Meaning	default
1	tt nn...	number nn under button tt	-
2	tt nn...	number nn under button tt	-
31	r m	relay r works in regime m (1-8)	11 21
31	r* tt	button tt causes switching on of relay r in regime m=6 (01-99)	01
32	rp hh...	In regime DAY + NIGHT password hh... for relay r , in order p=1-5 , for 1 impulse and p=* for 2 impulses (00-999999)	-
33	rp hh...	In regime DAY password hh... for relay r , in order p=1-5 , for 1 impulse and p=* for 2 impulses (00-999999)	-
34	rp hh...	In regime NIGHT password hh... for relay r , in order p=1-5 , for 1 impulse and p=* for 2 impulses (00-999999)	-
35	r aa	command aa from the phone for switching on relay r 1 impulse (00-99,*0-*9)	155 266
36	r cc	command aa from the phone for switching on relay r 2 impulses (00-99,*0-*9)	150 260
37	r ss	time ss [sec] of relay r switch on for time t1/t4 (01-99)	105 205
38	r p	Control of relay r during incoming call (0/1)	11 21
39	xx	period xx [sec] between switching on of relays 1 and 2 in regime m=5 – time length t3 (01-99)	10
30	r zz	period zz [sec] between impulses for switching on 2 impulses of relay r – time length t2/t5 (01-99)	105 205
3*	r e	Exit button for relay r (0/1/2)	10 20
3#0	p	p = 1 enabled / disabled p = 0 connection code relay COSW (0/1)	0
3#1	abcd	activation code 1 pulse from buttons (0000-1111)	0000
3#1	abcd	activation code 1 pulse from phone (0000-1111)	0000
3#1	abcd	activation code 2 pulses from buttons (0000-1111)	0000
3#1	abcd	activation code 2 pulses from phone (0000-1111)	0000
3#5	abcd	activation code from other modes of switch (0000-1111)	0000
41	v	Type of choice v – ton/impulse (0/1)	0

42	z	Sign for call prolonging (* / #)	*
43	g bb	Command for A-VBD disconnection from the phone (00-99,*0-*9)	155 266
44	xxxx	Service password (0000-9999)	0000
45	dd	Command for switch over to DAY (00-99,*0-*9)	11
46	nn	Command for switch over to NIGHT (0099,*0-*9)	10
47	e	Regime system choice (0/1)	1
49	o	Keyboard regime (0/1)	0
40	d	Choice DTMF from the keyboard during a call (0-3)	0
4*	k	Line disconnection by repeat press of the same button (0/1)	1
51	q	Umber of rings before A-VBD picks up (1-9)	2
52	d	Maximum length of call (0-9,*,#)	2
53	w	Time between button presses (1-9)	2
54	z	Time of disconnection for repeat choice (1-5)	2
55	z	Time before choice begins (1-5)	1
56	hh	Number of rings before disconnection (04-99)	12
500	x	Medium frequency of tone detector (1-0)	3 (375-475Hz)
501	y	Number of busy tones (2-0)	4
502	z	Length of time for permanent tone (1-5)	3 (3s)
503	tt	Length of time for DTMF (tone) choice (04-16)	10 (100ms)
504	mm	Length of time for gap between DTMF tones (04-16)	10 (100ms)
505	f	Length of time Flash (1-6)	1 (100ms)
506	p	Length of time for pause/inter-digit gap (1-0)	4 (800ms)
507	uu	Level of transmission of DTMF choice v [-dBm] (04-16)	10
508	p	preemphase DTMF (0/1)	0
509	S	Listening in DTMF – level (1-4)	2
61	z	Acoustic signalisation (confirmation, error, empty memory, end of call...) (0/1)	1

62	v	Acoustic signalisation Intro/Concl. (0/1)	1
63	u	Acoustic signalisation ticking into a call (0/1)	0
64	w	Internal power supply from connected supply 12V (DIP 3,4) (0/1)	0
65	z	Acoustic signalisation for relay switch on (0/1)	0
66	i	Suppression of reception DTMF from microphone (0/1)	0
67	b	Baby Call – call without the need to programme in number (0/1)	0
68	b	Mute at the lock activated (0/1)	0
6#	s	Setting of number of buttons on the main panel	2
6*	t	Delayed start for switchboards with line tests (Siemens) (0/1)	0
71	gg	Reception volume 01-16 (16 is the highest) (SPK)	07
72	ff	Transmission volume 01-16 (16 is the highest) (MIC)	07
73	rr	Speaker volume 01-16 (16 is the highest) (TRH)	07
74	c	Soft transition of switchover (0/1)	1
75	n	Suppression of background noise (0/1)	1
76	b	Threshold for switching on the microphone 1-4 (4 is the highest)	2
77	s	Speed of switching over voice atomisation 1-4 (is the slowest)	2
78	l	VA characteristic for line connection (0/1)	1
79	k	Compensation for loss of conduit depending on line current (0/1/2)	1
70	uu	Level of signalisation transmission in [-dBm] (04-16)	10
09	a	Switching on/off of automatic switch over Day/Night and control of time setting (0/1/#)	0
081	hhnn	Time setting hh-hours, nn-minutes	-
082	ddmmyyw	Date setting dd-day,mm-month,yy-year, w-day of the week	-
083	#	Waits 1 minute to reset to zero seconds	-
00	hhnnkkj j	Sunday – time setting hours hh and minutes nn starts day and hours kk and minutes jj starts night	00000000

01	hhnnkkj j	Monday - time setting hours hh and minutes nn starts day and hours kk and minutes jj starts night	00000000
02	hhnnkkj j	Tuesday - time setting hours hh and minutes nn starts day and hours kk and minutes jj starts night	00000000
03	hhnnkkj j	Wednesday - time setting hours hh and minutes nn starts day and hours kk and minutes jj starts night	00000000
04	hhnnkkj j	Thursday - time setting hours hh and minutes nn starts day and hours kk and minutes jj starts night	00000000
05	hhnnkkj j	Friday - time setting hours hh and minutes nn starts day and hours kk and minutes jj starts night	00000000
06	hhnnkkj j	Saturday - time setting hours hh and minutes nn starts day and hours kk and minutes jj starts night	00000000
07	#	overwrites (copies) setting from Sunday (00) to the whole week	-
8#	#	Basic setting	provide
81		Deletes all numbers in 1st group (regime Day)	
82		Deletes all numbers in 2nd group (regime night)	
83		Basic setting only for parameters 3x	only 3..
84		Basic setting only for parameters 4x	only 4..
85		Basic setting only for parameters 5x	only 5..
86		Basic setting only for parameters 6x	only 6..
87		Basic setting only for parameters 7x	only 7..
80		Basic setting only for parameters 0x	only 0..
9		E N D	

6 Technical parameters

6.1 Elektrical parameters

Parameter	Value	Conditions
Minimum line current	18mA	Line picked up
Minimum line voltage	18V	Line disconnected
Voltage on the line when A-VBD	< 8V	I = 20mA

picks up (VA characteristic)	< 12V ¹⁾	I = 60 mA
Lead in in disconnected state	< 30uA	U = 60V
Impedance of line ending	220R + 820R paral. 115nF	Line picked up
Bandwidth	300Hz – 3400 Hz	20 - 60mA
Impedence of ringing	> 2Kohm	25 – 60 Hz
Sensitivity of ringing detector	min. 10 – 25 V	
Impulse choice	40 / 60 ms	
Level of tone choice	-6 and -8 dB ¹⁾	20 – 60 mA
Sensitivity of tone choice	min. -40 dB	20 – 60 mA
Sensitivity of tone detector	min. -30 dB	20 – 60 mA
Power supply for name tag back lighting, relay, heating and current circuit for exit button	12V DC(11V-24V) , 12V AC(10V-18V)	
Max off take of backlighting and heating	250mA	12Vss
Max. Voltage of relay contact	48V	When I < 1A
Max. Current of relay contact	1,5A	When U < 30 V
Operating temperature	- 20 to + 60 st.	
Level of cover	IP45	
Weight	Depends on variation and composition	

1) Potential to change by programming.

6.2 Mechanical dimension

item	Dimension HxWxD [mm]			
	1 module	2 modules	3 modules	2 x 3 modules
Each module	100 x 100			
Flush mounting box	136x99x56	244x99x56	328x99x56	-
Fixing frame	173x128	256x128	358x128	-
Design frame	278x200	430x200	512x200	512x334
Roof – rain hood	156x134x40	258x134x40	361x134x40	361x234x40
Surface mounting box	156x134x80	258x134x80	361x134x80	361x234x80

7 Easy programming table

Fill in the values you want to programme into the empty part of the table, in the double framed part there are whole programming commands to make programming easier. You can keep the programmed values in the manual for future changes.

Meaning		Programming sequence		No of spaces
description	specify	par.	Fill the values	
Number under button 1	Day/1gr.	101		24
Number under button 2	Day/1gr.	102		24
Number under button 3	Day/1gr.	103		24
Number under button 4	Day/1gr.	104		24
Number under button 5	Day/1gr.	105		24
Number under button 6	Day/1gr.	106		24
Number under button 7	Day/1gr.	107		24
Number under button 8	Day/1gr.	108		24
Number under button 9	Day/1gr.	109		24
Number under button 10	Day/1gr.	110		24
Number under button 11	Day/1gr.	111		24
Number under button 12	Day/1gr.	112		24
Number under button 1	Night/2gr.	201		24
Number under button 2	Night/2gr.	202		24
Number under button 3	Night/2gr.	203		24
Number under button 4	Night/2gr.	204		24
Number under button 5	Night/2gr.	205		24
Number under button 6	Night/2gr.	206		24
Number under button 7	Night/2gr.	207		24
Number under button 8	Night/2gr.	208		24
Number under button 9	Night/2gr.	209		24
Number under button 10	Night/2gr.	210		24
Number under button 11	Night/2gr.	211		24
Number under button 12	Night/2gr.	212		24
Relay 1 works in mode	m=1 - 8	311		1
Relay 2 works in mode	m=1 - 8	312		1
Passw. for relay 1 (1 imp.)	Day+Night	3211		6

Passw. for relay 1 (1 imp.)	Day+Night	3212		6
Passw. for relay 1 (1 imp.)	Day+Night	3213		6
Passw. for relay 1 (1 imp.)	Day+Night	3214		6
Passw. for relay 1 (1 imp.)	Day+Night	3215		6
Passw. for relay 1 (2 imp.)	Day+Night	321*		6
Passw. for relay 2 (1 imp.)	Day+Night	3221		6
Passw. for relay 2 (1 imp.)	Day+Night	3222		6
Passw. for relay 2 (1 imp.)	Day+Night	3223		6
Passw. for relay 2 (1 imp.)	Day+Night	3224		6
Passw. for relay 2 (1 imp.)	Day+Night	3225		6
Passw. for relay 2 (2 imp.)	Day+Night	322*		6
Passw. for relay 1 (1 imp.)	Day	3311		6
Passw. for relay 1 (1 imp.)	Day	3312		6
Passw. for relay 1 (1 imp.)	Day	3313		6
Passw. for relay 1 (1 imp.)	Day	3314		6
Passw. for relay 1 (1 imp.)	Day	3315		6
Passw. for relay 1 (2 imp.)	Day	331*		6
Passw. for relay 2 (1 imp.)	Day	3321		6
Passw. for relay 2 (1 imp.)	Day	3322		6
Passw. for relay 2 (1 imp.)	Day	3323		6
Passw. for relay 2 (1 imp.)	Day	3324		6
Passw. for relay 2 (1 imp.)	Day	3325		6
Passw. for relay 2 (2 imp.)	Day	332*		6
Passw. for relay 1 (1 imp.)	Night	3411		6
Passw. for relay 1 (1 imp.)	Night	3412		6
Passw. for relay 1 (1 imp.)	Night	3413		6
Passw. for relay 1 (1 imp.)	Night	3414		6
Passw. for relay 1 (1 imp.)	Night	3415		6
Passw. for relay 1 (2 imp.)	Night	341*		6
Passw. for relay 2 (1 imp.)	Night	3421		6
Passw. for relay 2 (1 imp.)	Night	3422		6
Passw. for relay 2 (1 imp.)	Night	3423		6
Passw. for relay 2 (1 imp.)	Night	3424		6
Passw. for relay 2 (1 imp.)	Night	3425		6
Passw. for relay 2 (2 imp.)	Night	342*		6

Button choice for 1 relay	m=6	311*	2
Button choice for 2 relay	m=6	312*	2
Switch on r 1 from phone	1 impulse	351	2
Switch on r 2 from phone	1 impulse	352	2
Switch on r 1 from phone	2 impulses	361	2
Switch on r 2 from phone	2 impulses	362	2
Length of time for r 1 switch on	[sec]	371	2
Length of time for r 2 switch on	[sec]	372	2
Control of r 1 during incoming call	1 / 0	381	1
Control of r 2 during incoming call	1 / 0	382	1
Length of time between switch on r 1 and 2	[sec]	39	2
Length of time between impulses of r 1	[sec]	301	2
Length of time between impulses of r 2	[sec]	302	2
Exit button for r 1	0/1/2	3*1	1
Exit button for r 2	0/1/2	3*2	1
Enable code relay (COSW-sw.1)	0/1	3#0	1
code for activation 1 imp./btn.	0000-1111	3#1	4
code for activation 1 imp./phn.	0000-1111	3#2	4
code for activation 2 imp./btn.	0000-1111	3#3	4
code for activation 2 imp./phn.	0000-1111	3#4	4
code for activation other mode	0000-1111	3#5	4
Type of choice tone / imp.	0 / 1	41	1
Sign for prolonging of call	* / #	42	1
A-VBD disconnection from phone	1.	431	2
A-VBD disconnection from phone	2.	432	2
Service password		44	4
Command for switch over to DAY		45	2
Command for switch over to NIGHT		46	2
Regime system choice	1 / 0	47	1
Keyboard regime	1 / 0	49	1
choice DTMF from	0/1/2/3	40	1

keyboard				
Disconnection by repeat press of the same button	0 / 1	4*		1
Number of rings for pick up		51		1
Maximum length of time	[min]	52		1
Time between button presses	[sec]	53		1
Time of disconnection for repeat choice	[sec]	54		1
Time before choice commences	[sec]	55		1
Number of rings before disconnection		56		2
Frequency of tone detector	table	500	ms	1
Number of busy tones		501		1
Length of time of permanent tone		502	sec	2
Length of time of tone choice	nn x 10	503	ms	2
Gap between DTMF tones	nn x 10	504	ms	2
Length of time Flash	n x 100	505	ms	1
Length of time of pause / gap	n x100+400	506	ms	1
Transmitting level DTMF	04-16	507	-dBm	2
preemphasis DTMF	0 / 1	508		1
Listening in DTMF - level	1-4	509		1
Acoustic signalisation (other)	0 / 1	61		1
Acoustic signalisation Intro/Concl.	0 / 1	62		1
Acoustic sign. ticking	0 / 1	63		1
Internal power supply from 12V	0 / 1	64		1
Signal tone turning on relay	0 / 1	65		1
Suppression of reception from microphone	0 / 1	66		1
Baby Call	0 / 1	67		1
Mute at the lock activated	0 / 1	68		1
no of buttons on the panel	Type dependant	6#		1
Delayed start (Siemens)		6*		1
Reception volume (TRH)	01-16	71		2
Transmitting volume (MIC)	01-16	72		2

Speaker volume (SPK)	01-16	73		2
Soft transition of switch over	0 / 1	74		1
Suppression of background noise	0 / 1	75		1
microphone switch on threshold	1 - 4	76		1
Speed of switching over voice atomization	1 - 4	77		1
VA characteristic	0 / 1	78		1
Compensation for loss of conduit	0 / 1 / 2	79		1
Level of signalisation transmission	04 - 16	70	-dBm	2
On/off automatic switch over	0 / 1 / #	09		0
Time setting	hhnn	081		4
Date setting	ddmmyy	082		6
Sunday	hhnnkkjj	00		8
Monday	hhnnkkjj	01		8
Tuesday	hhnnkkjj	02		8
Wednesday	hhnnkkjj	03		8
Thursday	hhnnkkjj	04		8
Friday	hhnnkkjj	05		8
Saturday	hhnnkkjj	06		8

*note. hours **hh** and minutes **nn** starts **day** and hours **kk** and minutes **jj** starts **night***

WARRANTY:

Each and every product has been tested before it leaves the factory.

The manufacturer guarantees that the product and its features will work in accordance with the descriptions in this manual as long as the customer uses the product in accordance with the manufacturer's instructions.

Warranties will be extended when a warranty repair has been undertaken.

Although all warranty repairs will be handled by the manufacturer it is important that warranty claims are handled through your dealer. Warranty claims should be accompanied by:

- The product in question
- A description of the problem
- Proof of purchase and
- Your full name and address.

The warranty does not cover:

- Mechanical, chemical, thermal or any other faults cause by the user
- Faults caused by natural disasters
- Faults caused by repairs or changes made by the user or any other authorised or unauthorised person(s)
- Purposely done damage
- Incorrect use of the product, caused by incorrect installation, programming etc., and
- Damages cause during the transport of the product to and from the purchaser.

Manufacturer:

Dealer:

Date of sale:

