

# **A-Bell – Door Entry Phone**

for analog telephone line

*A-Bell - C*  
*A-Bell - LC*  
*A-Bell - C/C*  
*Bell-8*



User and service manual  
Version 1.0



## *Dear customer*

Congratulations to the purchase of "A-Bell door entry phone".

This manual describes a version in the following variants with one or two pushbuttons:

- A-Bell - C - full version (Comfort)
- A-Bell - C/C - full version (Comfort) with analog Camera
- A-Bell - LC - reduced version (Low Cost)

### **Basic features of the A-Bell doorphone**

- 30mm thin, surface mount design without necessity to cut a hole into the wall
- LED illumination of name plates
- integrated analog colour camera (C)
- two independent relay switches with 8 modes of setting (C)
- possibility to use power supply of the electrical lock for powering the doorphone in case of connection to some problematic PBXs (replaces BestBox) and for modes of switches with permanent status (C)
- electronic setup of loudness without necessity to open the front cover
- adjustable detection of tones for line hang up or repeated calling
- integrated RTC circuit of clock - automatic day/night switching (C)
- programming via DTMF telephone or via USB cable from PC
- 24-digit length of telephone number including \* # Flash and Pause

(C) – full version only (Comfort)



Manual version V1.0 14.9.2011  
ALPHATECH TECHNOLOGIES s.r.o.  
Jeremenkova 88  
140 00 Praha 4  
CZ  
[www.alphatechtechnologies.cz](http://www.alphatechtechnologies.cz)  
[info@alphatechtechnologies.cz](mailto:info@alphatechtechnologies.cz)

# Contents

---

<b>1</b>	<b>BASIC DESCRIPTION.....</b>	<b>6</b>
1.1	FEATURES .....	6
1.2	TERMINOLOGY .....	7
1.3	VERSION OF A-BELL DOORPHONE AND DIFFERENCES .....	8
1.4	MODELS OF A-BELL DOORPHONE .....	9
1.5	PCB SCHEMATICS .....	11
<b>2</b>	<b>INSTALLATION.....</b>	<b>14</b>
2.1	ASSEMBLY OF A-BELL DOORPHONE .....	14
2.1.1	<i>Dismounting of the front cover of A-Bell</i> .....	14
2.1.2	<i>Wall mounting of A-Bell</i> .....	14
2.1.3	<i>Replacement of name plates</i> .....	15
2.1.4	<i>Demounting and mounting of pushbutton in the front panel</i> .....	15
2.1.5	<i>Closing the front cover of A-Bell</i> .....	16
2.2	INTERCONNECTION OF TWO MODULES .....	16
2.3	CONNECTION .....	17
2.4	CAMERA (VERSION /C ONLY) .....	21
2.5	OTHER ACCESSORIES .....	22
2.5.1	<i>TimeRelay</i> .....	22
2.5.2	<i>DistyBox</i> .....	22
2.5.3	<i>Power supply 12V</i> .....	22
2.5.4	<i>USB programming cable</i> .....	23
2.5.5	<i>BlackBox</i> .....	23
<b>3</b>	<b>OPERATING THE UNIVERSAL DOORPHONE.....</b>	<b>24</b>
3.1	SIGNALLING OVERVIEW .....	24
3.2	VISITOR AT THE DOOR ENTRANCE .....	25
3.1	PERSON INSIDE THE BUILDING.....	28
3.1.1	<i>Outgoing call</i> .....	28
3.1.2	<i>Incoming call</i> .....	29
<b>4</b>	<b>PARAMETERS PROGRAMMING .....</b>	<b>30</b>
4.1	PROGRAMMING BY PHONE .....	30
4.1.1	<i>Entering into programming</i> .....	30
4.1.2	<i>Parameters programming</i> .....	30
4.2	PC PROGRAMMING – BELLSET PROGRAM .....	31
<b>5</b>	<b>DESCRIPRION OF PROGRAMMABLE PARAMETERS.....</b>	<b>32</b>
5.1	DIRECT NUMBERS DIAL – MEMORIES.....	32
5.2	RELAYS.....	33
5.3	BASIC PARAMETERS .....	37
5.4	TIME PARAMETERS.....	39

5.5 SYSTEM PARAMETERS ..... 42  
5.6 HANDSFREE PARAMETERS SETTING ..... 45  
5.7 TIME PROGRAM – AUTOMATIC DAY/NIGHT SWITCHING (C)..... 48  
5.8 DEFAULT SETTTING AND ERASING ..... 50  
5.9 PROGRAMMING TERMINATION ..... 50  
5.10 OVERWIEV OF PARAMETERS ..... 51

**6 TECHNICAL PARAMETERS..... 55**

6.1 ELECTRICAL PARAMETERS ..... 55  
6.2 MECHANICAL DIMENSIONS ..... 55

**7 TABLE FOR EASY PROGRAMMING..... 56**

# 1 Basic description

---

## 1.1 Features

- voice communication is powered from the telephone line only
- pulse and tone (DTMF) dialling
- two 24 digit numbers can be stored for each pushbutton (including \*, #, Flash and pause)
- expansion by Bell-8 module up to 98 pushbuttons (under development)
- Day / Night switching by DTMF code or automatically according to internal RTC clock (C)
- call prolongation by dialling \* or # character
- two independent locks for door opening can be connected (C)
- 8 modes of switches (e.g. add-on bell, progressive opening)
- two codes for hanging up the doorphone from the telephone
- two codes for opening the door from the telephone for 1 pulse and two codes for 2 pulses
- 3 x 6 codes for each relay (password entered via pushbuttons at the door entrance)
- selectable number of rings before the incoming call is answered
- adjustable parameters of tone dialling, length of Flash and Pause
- adjustable parameters of acoustic signalling
- adjustable parameters of tones detector
- electronic adjusting of loudness without necessity to open the front cover of the doorphone
- integrated analog colour camera with permanent or automatic operation /C
- automatic illumination of camera with infra LED /C
- possible permanent powering from an external 12V power supply (replaces the old solution of BestBox add-on unit) /C (C)
- easy setting of HW with the DIP switch
- factory default settings pre-set at several levels
- programming either remotely via DTMF dialling or via a direct connection to the PC
- integrated heating of the PCB circuit board
- permanent illumination of name plates
- ground output for better protection against static electricity

(C) – full version only (Comfort)

/C - camera version only

## 1.2 Terminology

<b>telephone line</b>	analog (2 wire) is a way of connection to the public telephone network ( <b>PSTN line</b> ) or connection to the private branch exchange telephone switch - PABX at the place of installation ( <b>extension line</b> )
<b>line picking up</b>	beginning of the telephone connection (call), similar to OFF HOOK when the telephone handset is off the cradle
<b>line hanging up</b>	end of call, similar to ON HOOK when the telephone handset is on the cradle
<b>dial/dialling</b>	<b>DTMF</b> - tone, it is dialling by a combination of two tones (dialling also special characters * and #, it uses Flash loop interruption) <b>Pulse</b> – dialling by line interruption (dials digits only)
<b>incoming call</b>	connection between A-Bell and telephone has been established by dialling on the telephone. A-Bell answers the call after a set number of rings. After it picks up the line and entering a password, you can program A-Bell from your telephone
<b>outgoing call</b>	connection between A-Bell and the telephone has been established by dialling of the A-Bell doorphone, e.g. after pressing a pushbutton
<b>call establishing</b>	status when the called party answers the call after the number has been dialled. This status is not signalled on the analog line, only the ringing tone ends and the call is established. It is difficult to identify this moment exactly
<b>code lock</b>	function for closing the relay by entering a combination of the first 10 pushbuttons or buttons of the keypad (after pressing the symbol of key)
<b>external code</b>	combination entered with the first 10 pushbuttons or buttons of the keypad (after pressing the symbol of key) for relay switching. External code = it is entered on the A-Bell doorphone – outside the building
<b>internal code</b>	combination entered on the phone for relay switching (DTMF). Internal code = it is entered inside the building
<b>Bell</b>	new solution of analog doorphones with expanded offer of available parameters
<b>BellSet</b>	PC setup program for easy parameters' settings of the new doorphones belonging to the Bell group



A-Bell is a member of new analog doorphones group. This modern solution offers a comprehensive and wide range of features meeting demands even of the most exacting customers.

### 1.3 Version of A-Bell doorphone and differences

**A-Bell** doorphone is framed as an open project for its final use inside a specific mechanical design (housing). Features and parameters which can be set are designed for the maximum version and individual versions differ by exploiting the features of the maximum version. Therefore it is necessary to define basic parameters which are the same for all versions and add-on parameters for individual mechanical design lines (for different housings).

In this manual you will find various features marked with marking letters. The features marked as **(C)** are valid for the full version of A-Bell (**C**omfort) and features marked as **(M)** are available in the **M**aximum version only (not available for A-Bell doorphone).

#### Marking of available features:

version **LC** (LowCost – price reduced) has got all features available except for those which are especially marked with marking letters, see below.

version **/C** is version equipped with a colour analogue camera

version **C** (**C**omfort full) has got marking **(C)**

version **M** (maximum) has got marking **(M)** – in the mechanical housing of A-Bell it is not produced and it is mentioned in the manual only at programming parameters which are common for all analog doorphone versions.



## 1.4 Models of A-Bell doorphone

LC and C versions of A-Bell doorphone contain the basic board which is equipped according to its type with all connection and construction elements.



A-Bell- 01C  
A-Bell- 01LC



A-Bell- 01C/C



A-Bell- 02C  
A-Bell- 02LC



A-Bell- 02C/C



Expansion module Bell-8

The basic module of doorphone can contain one or two pushbuttons. In the future it can be expanded by up to 12 modules of Bell-8. That means  $12 \times 8 = 96$  pushbuttons. The maximum number of pushbuttons of the A-Bell doorphone can then be 97 / 98.

Models **LC** and **C** differ according to the components set on the board. In the version (**LC**) there are missing:

- second relay
- camera option
- RTC internal clock for automatic Day-Night switching
- possibility of external power supply (it can be used for relay modes 7 and 8)
- possibility to switch off the illumination of name plates (visit cards)

Models with a camera **IC** are equipped in addition with:

- automatic / permanent illumination for the camera (infra)
- disconnectable internal impedance for the camera cable end 75ohm
- indication of the status with red LED diode

## 1.5 PCB schematics

All functional and connection elements are marked with a number on the figure below and explanation can be found on the next page.

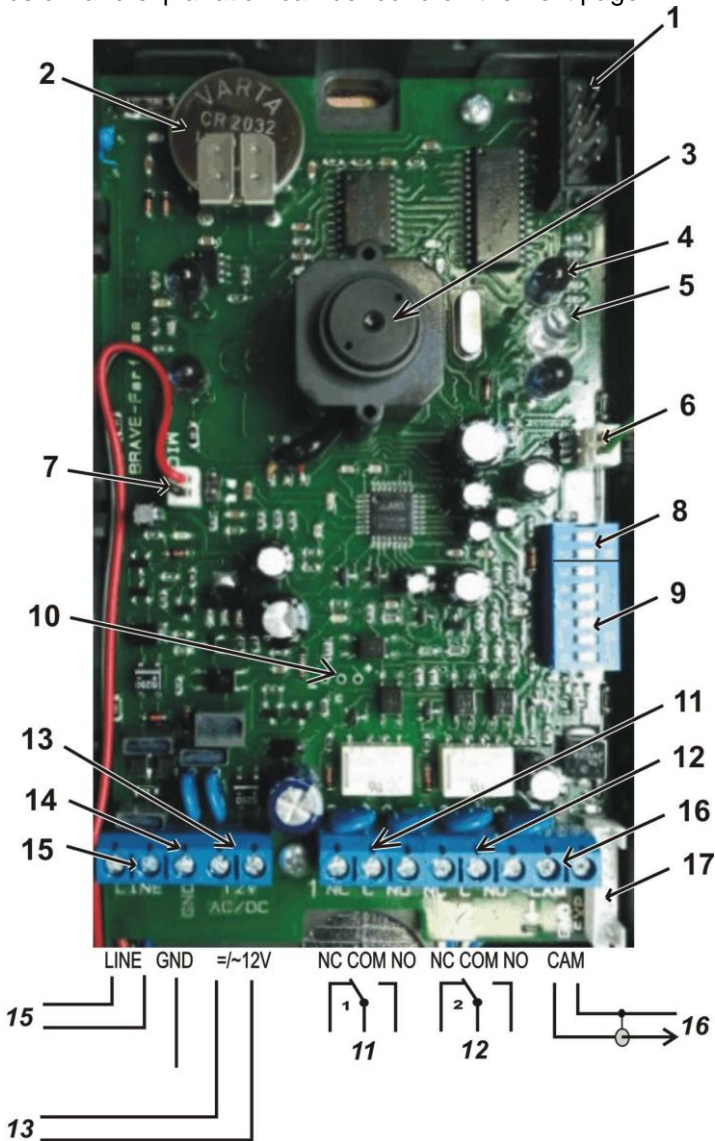

**Fig. 1** The main PCB board of the A-Bell doorphone

*(2) + (9) + (12) only in version (C)*

*(3) + (4) + (5) + (16) only in version /C*

1. Connector for PC connection via USB cable (the same cable as for the NUDV doorphone)
2. Back up battery and RTC circuit in version **(C)**
3. Analogue colour camera – *only in version with a camera /C*
4. Illumination of camera - infra LEDs illuminating the area in front of the camera. They are active only when the camera is in operation. It is possible to turn off the infra LEDs (see point 7) - *only in version with a camera /C*
5. LED indication of doorphone status (red) - *only in version with a camera /C*
6. Connection of loudspeaker
7. Connection of microphone (attention to polarity)
8. DIP switch in all versions:
 

on	<input type="checkbox"/>	<input type="checkbox"/>	<input type="checkbox"/>	<input type="checkbox"/>	<input type="checkbox"/>	<input type="checkbox"/>	<input type="checkbox"/>	<input type="checkbox"/>
off	<input type="checkbox"/>	<input type="checkbox"/>	<input type="checkbox"/>	<input type="checkbox"/>	<input type="checkbox"/>	<input type="checkbox"/>	<input type="checkbox"/>	<input type="checkbox"/>
	1	2	3	4	5	6	7	8

  - 1 = Service, usage – if you forget password then incoming call goes to the programming mode directly. Here you can set a new password.
  - 2 = Heating – it switches on an integrated heating of the board in order to eliminate condensation of water during temperature changes
9. DIP switch in full version **(C)** and in version with a camera **/C**:
  - 3 = external power supply
  - 4 = external power supply – 3 a 4 are always switched together at the same time. Power supply is supplied from screw 12V (13) and there are two reasons to use external power supply:
    - use of switch mode 7 or 8 – permanent closing/opening of the switch can be done with an external power supply only. Do not forget to set parameter 64, too.
    - connection of the doorphone to the line of PBX, which has got troubles with consumption of current on its extension lines during the start (Siemens). This mode fully replaces usage of an external box solving this issue (BestBox).
  - 5 = Camera illumination (switches on / off illumination of area in front of the camera by using infra LED)
  - 6 = Illumination of name plates (switches on / off LED illumination of name plates next to the pushbutton)
  - 7 = Switches on permanent operation of camera, in default the camera is active only during active operation of the doorphone
  - 8 = Enables connection of 75ohm load on the camera output - impedance
10. Input for connection of an exit button or a code reader e.g. RFID or Dallas
11. Relay 1, galvanically isolated, max. load is 48V, max. 1,5A
12. Relay 2, galvanically isolated, max load is 48V, max. 1,5A – only in version **(C)**
13. 12V power supply:
  - relay control
  - motherboard heating
  - backlight illumination of nameplates
  - camera powering and infra LED lighting up
  - external powering of the unit (DIP 3 and 4)

The power supply can be either DC or AC, it does not depend on polarity, from 12V max consumption is 250mA.

The power supply can be also used for powering of the electrical lock. In this case we recommend a power supply 12V/1A.

You can also use 24VDC power supply. You can make use of it during installation especially at places where there is already a power supply which is used for e.g. time attendance, access control or sliding gate. The mainboard heating has got a regulation element for power restriction, other circuits are designed for 24VDC. You must not use an AC power supply, only DC power supply is allowed. It does not depend on polarity.

14. Grounding – connection to the ground for protection against static electricity – it protects doorphone's electronics and the telephone system.
15. Analog telephone line (it does not depend on polarity)
16. Camera output - PAL video 1V / 75ohm, for distances over 25m we recommend using a coax cable, you can also use a UTP cable – *for camera versions only /C*
17. Connector for connecting the expansion pushbutton module Bell-8

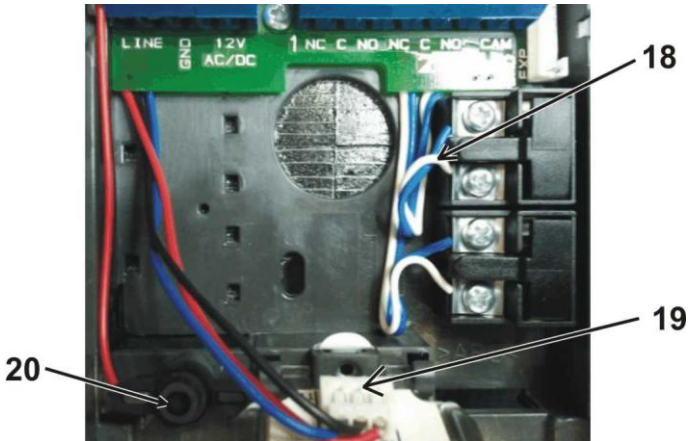
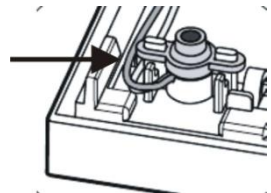

Fig. 2 Connection of pushbuttons on the main PCB board

18. Connection of pushbuttons to the basic module
19. Connection of backlight illumination for nameplates to the basic module
20. Microphone



## 2 Installation

### 2.1 Assembly of A-Bell doorphone

#### 2.1.1 Dismounting of the front cover of A-Bell

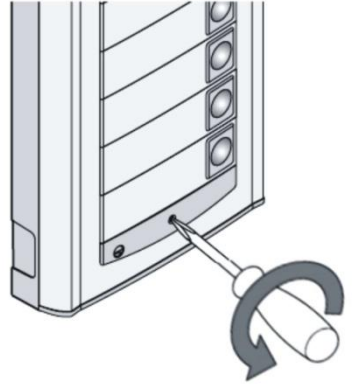

#### 2.1.2 Wall mounting of A-Bell

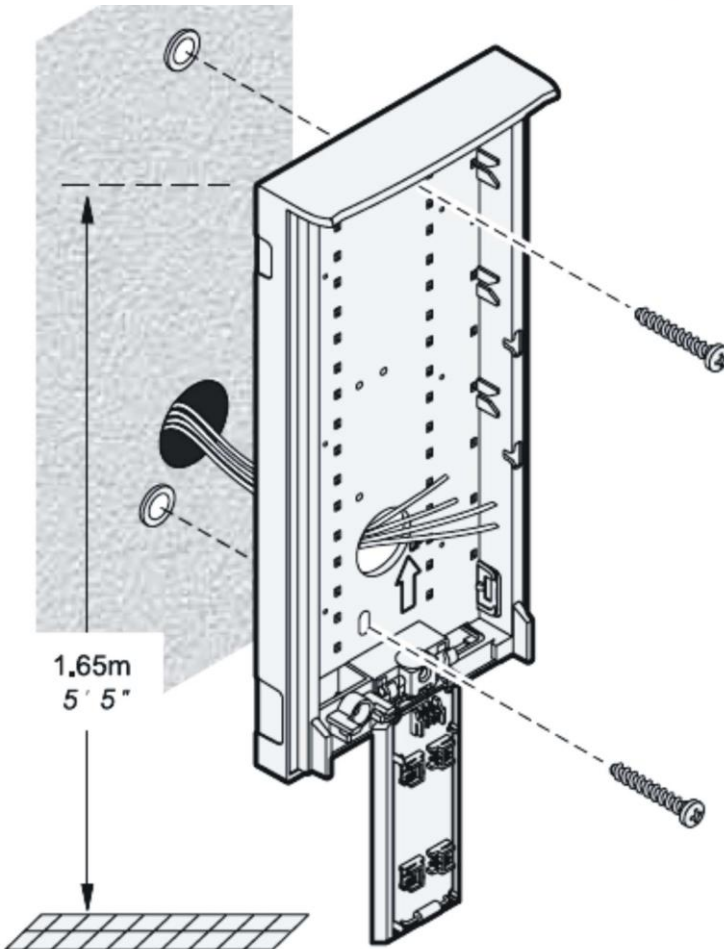

Mounting is done with wall plugs and screws. We suggest wall plugs with **5mm** in diameter, the screw with half-round head, diameter **4mm**, length **35mm**

### 2.1.3 Replacement of name plates

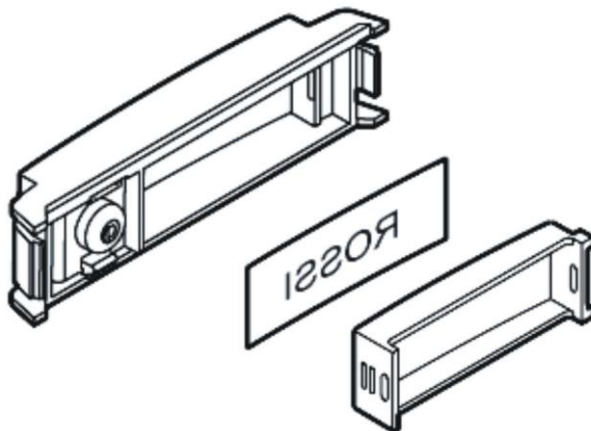

Each pushbutton has got its own label held with the white plastic cup (see the figure above). Demounting and inserting of the cap can be done with two fingers along the longer side of the cap by a soft pull / push.

### 2.1.4 Demounting and mounting of pushbutton in the front panel

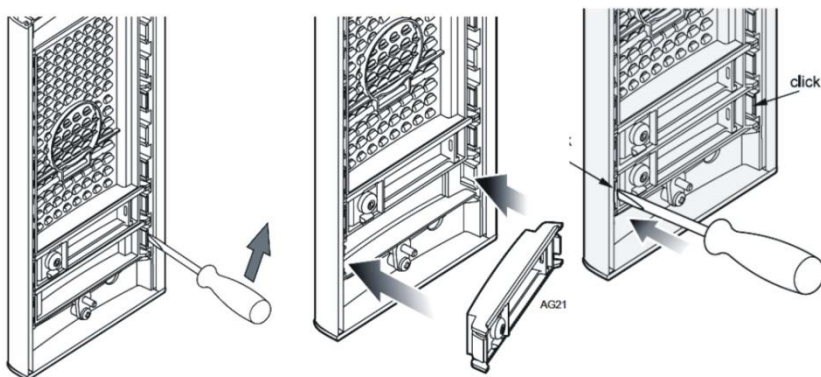

## 2.1.5 Closing the front cover of A-Bell

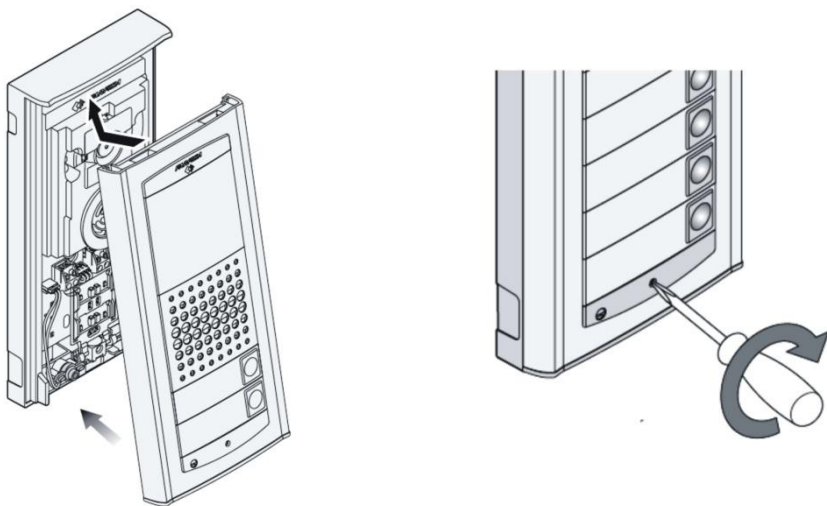

## 2.2 Interconnection of two modules

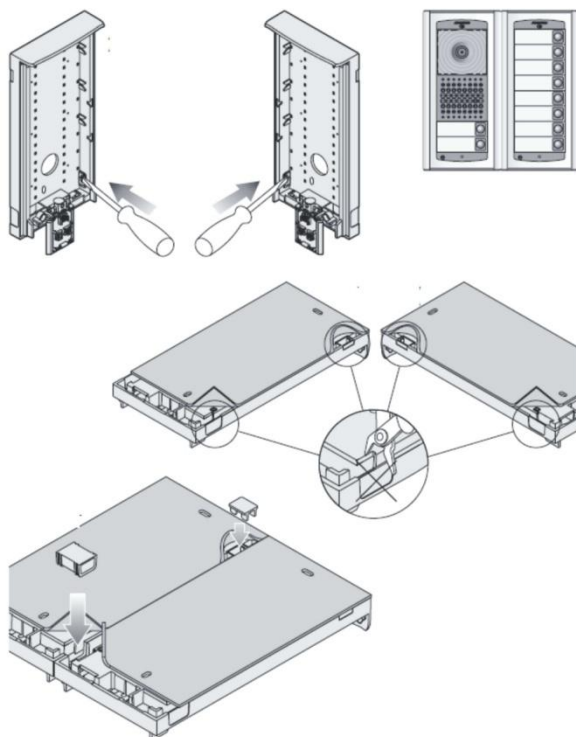



## 2.3 Connection

For the basic functionality of the doorphone (i.e. voice communication) you need to connect the **telephone line** only - **LINE (8)** on Fig. 1 The main PCB board of the A-Bell. The line is connected by 2 wires (a,b) and in stand-by it has got usually a voltage of 24V - 60V, short circuit current 20mA - 60mA. When the line is OFF HOOK, the line voltage is 7V - 10V.

**Line connection** of A-Bell is announced by a sound signal (Reset) 🎵 when it is disconnected from the line for a certain time. A-Bell is an analog doorphone designed for connection to an analog line (PSTN line or PBX analog extension). It means a line to which a standard analog telephone can be connected. It works regardless to line polarity and in the range specified in the technical parametres (chapter 6).

**Paralel connection** – we do not recommend! A paralel connection with other analog phone or other doorphone is not recommended! We also do not recommend using special devices switching the line (intelligent couplers/phone sockets, adapters, etc.).

When you use A-Bell with a **camera /C** then you need to connect the cable for video transmission on the screw **CAM (16)**, see Fig. 1. For distances of up to 25m you can use one free pair of a UTP cable. For longer distances you need to use a coax cable, see Fig. 1. The camera mode is setup by a DIP switch and the camera is either activated automatically (when the doorphone is active) or is permanently ON (DIP 7). The camera illumination provided by infra LED is either active when the camera is on (DIP 5) or you can switch it OFF pernamently. DIP 8 enables paralel connection of 75ohm impedance load to the video output.

**12V power supply (13)** on Fig. 1 must be connected to provide mother board heating, nameplates backlighting, camera powering including infra LEDs and relays control. The power supply might be either AC or DC, it does not depend on polarity. From 12V the max consumption can be 250mA. The power supply might be also used for electrical lock powering. In such case we recommend to use a power supply 12V/1A. You can also use 24VDC power supply. It is useful especially at installations where there is a power supply installed already and it is used for sliding gate, time attendance system, etc.

**Relays (10)** on Fig. 1 have many possibilities of practical use. The examples (drawings) can be found on Fig. 3. 12V power supply must be connected for correct operation. The doorphone unit has got all important parts galvanically isolated. The telephone line is isolated from the power supply. The relays' contacts are also galvanically isolated from other doorphone electronic parts.

**It is absolutely forbidden to connect the doorphone to the mains power supply of 120V or 230V!!!** When you need to control devices

connected to the mains power supply, please use contactors (power relays) as shown on Fig. 3 example (6).

**Relays connection examples** are mentioned on the following page. There are not all of them but it can give you an idea how individual circuits should be connected (red rings with numbers = example numbers).

1. Basic connection - 2 electrical locks and possibility to control two doors independently. (relay mode 1 and 2 m=1) or progressive door opening (relay mode 2 m=5 - version **(C)** only).
2. Two power supplies – possibility to use two power supplies independently. One power supply for A-Bell and the second one for electrical locks. The second electrical lock is connected inversaly (fire emergency exit).
3. Combination of doors with electrical lock and sliding gate at fencing.
4. Extending the previous example (3) to two doors with progressive opening (this feature is setup in the TimeRelay unit, which is an optional add-on module)
5. Combination of electrical lock and additional ring. Relay of additional ring might be in mode m=4 (from each button it is activated for preprogrammed time) or in mode m=6 (it is activated from one preset button for preprogrammed time)
6. Lighting activation m=3 (for example: a path to the building) and control of for example: heating up DAY/NIGHT mode m=8 ( **(C)** version only - RTC circuit). External power supply required (DIP 3 and 4) **/C** version only. Further it is necessary to use contactor (A-Bell **must not** activate 230V!).

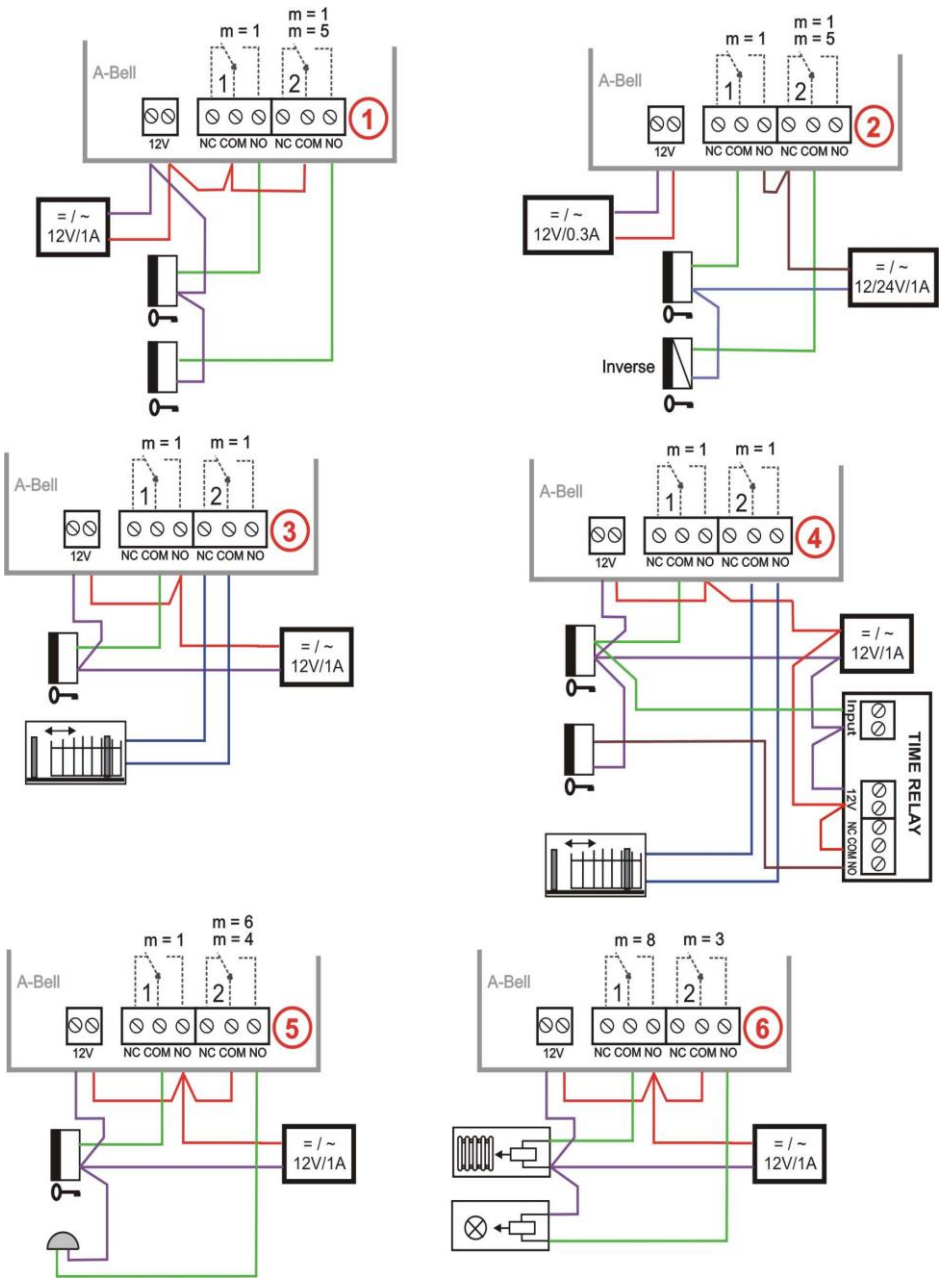
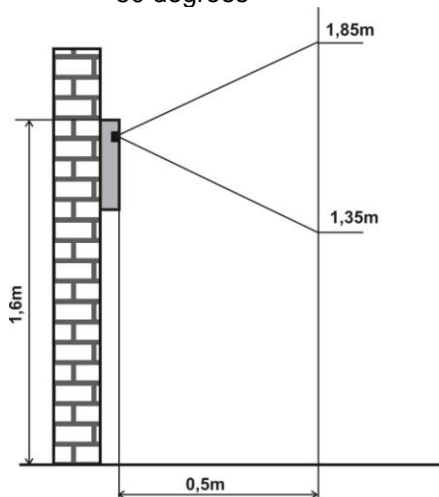

**Fig. 3 Examples of relay connection**

## 2.4 Camera (version /C only)

### Technical parametres:

- videonorm: PAL-CCIR
- sensor: CMOS 1/3"
- image area: 5,78x4,19mm
- resolution: 628x582pixel 380 rows
- video output: 1V p-p/75 ohm
- automatic gain control: 18dB
- minimum illumination: 3LUX
- automatic lens shutter: 1/60-1/15000sec.
- camera view: 50 degrees



- focus: manually with a tool

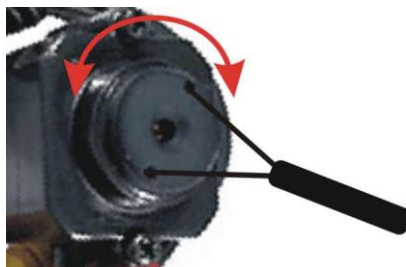

## 2.5 Other accessories

### 2.5.1 TimeRelay

Time relay enables expanding functionality of relays. It is a standalone, add-on product. For further details please contact us via [www.alphatechtechnologies.cz](http://www.alphatechtechnologies.cz)

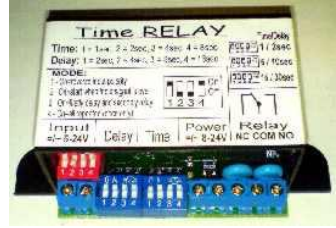

### 2.5.2 DistyBox

This optional, add-on module in a plastic box allows you to connect analog unit (phone, doorphone) into DECT – GAP wireless system (for example Siemens GigaSet, TopCom Butler etc.). DistyBox is suitable for doorphone connection when cabling is not available. You just register the doorphone as a handset to the DECT base station. All features of doorphone are maintained.



**Important:** The DECT base station must support DTMF transmission between each handset to enable the relay activation feature.

### 2.5.3 Power supply 12V

A-Bell doorphone uses 12VAC/1A power supply. Optionally you can order it as add-on product. If you need more info on power supplies or electrical locks, please contacts us via [www.alphatechtechnologies.cz](http://www.alphatechtechnologies.cz)



### **2.5.4 USB programming cable**

Item number 212124. If you need SW drivers for this PC USB programming cable „USB-KAB“, please contact us via [www.alphatechtechnologies.cz](http://www.alphatechtechnologies.cz)



### **2.5.5 BlackBox**

The BlackBox unit is a DTMF modem used for remote programming via PC. The BellSet SW used by BlackBox enables remote setup of A-Bell parameters.















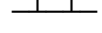

## 3 Operating the universal doorphone

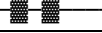
A-Bell functions are influenced by setup of its parameters (see chapter 4).

### 3.1 Signalling overview

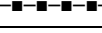
A-Bell doorphones signals its statuses acoustically, which can occur during operation. Sound samples of signalling can be played in the BellSet setup SW.

Status	Tones	Tone frequency
Line pick up ( OFF HOOK) type 1		980-1333-1650
Line hang up ( ON HOOK) type1		1650-1333-980
Line pick up ( OFF HOOK) type 2		800-1067-1200-1333
Line hang up ( ON HOOK) type2		1333-1200-1067-800
Command confirmation by phone		800
Alerting (knocking) into call		
Call ending alert		1333
Relay activation signal		Modulated
Entering into programming mode by phone		980-1067-1180
Programming by phone		Modulated
Parametr confirmation		800
Programming enter by PC		980-1067-1180
Line connection (Reset)		1850-1067-1850
Error (generally anything incompatible)		800
Memory empty (no number programmed)		1300-2100

When there is a problem during installation, it is useful to know what tones are played by the doorphone. These tones help you analyse the doorphone status and its functionality better. Tones signalling can be disabled by SW setup in several levels (*parameters 61,62,63 and 65*).



## 3.2 Visitor at the door entrance

Pushbuttons of the doorphone have got name plates such as normal doorbell buttons. The visitor chooses desired name (e.g. "Cech") and presses the pushbutton. The A-Bell doorphone picks up the line, "plays" a tone of line pickup (if it is not disabled with the parameter 62) and dials a preset telephone number stored in the memory of the pushbutton (*parameter 1 or 2* according to the mode of the doorphone). From the speaker of the A-Bell doorphone you can hear a ringing tone and the telephone of Mr. Cech is ringing. As soon as Mr. Cech answers the call, he can speak with the visitor at the door entrance. If there is an electric lock connected to the A-Bell doorphone, then Mr. Cech can open the door by dialling a DTMF code on his telephone. If he hangs up the telephone, then the A-Bell doorphone also hangs up the line after detecting a busy tone. If the call duration is longer than a preset limit (*parameter 52*) then 10sec. before the line hangs up the A-Bell doorphone sends a tone of call end. If Mr. Cech dials star character „\*“ or hash character “#“ according to settings (*parameter 42*), then the call will be extended again by a time period set in the *parameter 52*.

Dialed number differs by a mode of dialling set in the doorphone (*parameter 47*):

- **mode Day/Ningt** = if the doorphone is set in mode Day, then it always dials a number set in *parameter 1*. If it is set in mode Night, then it always dials a number set in *parameter 2*. Manual switching of modes is set in *parameters 45,46*. In version **(C)** you can activate Day/Night switching to automatic mode. Then selection of dialled number follows time settings according to a table (*parameters 00-06*).
- **mode 2 groups** of numbers = by pressing the pushbutton once – always dials a number preset in *parameter 1*. If you press the same pushbutton one more time or if a busy tone is detected 10sec. after dialling, or after elapsing a set number of rings (*parameter 56*), the doorphone dials a number from the second group (*parameter 2*). If you press the same pushbutton again, a number from the first group is dialled etc. (after detection of busy tone of the telephone number in the second group the repeated dialling is finished)

If the visitor presses the pushbutton after the doorphone picked up the line, then the doorphone hangs up for a time period set in *parameter 54*, it picks up the line again and dials a new number. Dialling of the number is executed either by tone (DTMF) or pulse dialling according to settings in the *parameter 41*. One more option is available – hanging up the line by a repeated pressing of the same pushbutton (*parameter 4\**).

The first 10 pushbuttons of the doorphone can be used for operating the relay switch (**code lock function**). If the visitor at the door entrance presses pushbuttons in the right combination according to preprogrammed code (*parameter 32-34*) and the time period between individual preses is not longer than defined (*parameter 53*) then the doorphone picks up the line, switches the

correct relay switch (if it is set in mode  $m=1$  or mode  $m=5$ ) for a time period set in the *parameter 37 or alternatively 39,30*. Then it hangs up.

According to the control code the relay can switch one impulse or two impulses with time period between impulses set in the *parameter 30*, see table *Note*:









t1 – time activation 1 of relay (*parameter 371*)

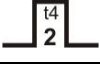
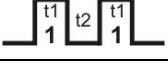
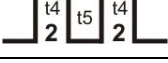
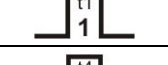
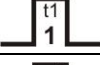



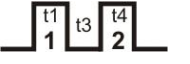
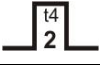
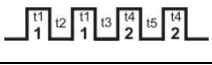

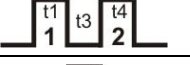
t2 – time between pulses 1 of relay (*parameter 301*)

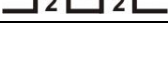
t3 – time between activation 1 and 2 relay (*parameter 39*)

t4 – time activation 2 of relay (*parameter 372*)

t5 – time between pulses 1 of relay (*parameter 302*)

<b>mode m = 1</b> (parameter 3111 and 3121)			
<b>Action</b>	<b>Note</b>	<b>Parameter</b>	<b>Relay</b>
<b>Evaluation of correct external code from buttons</b>	According settings DAY/NIGHT	3211-3215	
		3311-3315	
		3411-3415	
	According settings DAY/NIGHT	3221-3225	
		3321-3325	
		3421-3425	
	According settings DAY/NIGHT	321*	
		331*	
		341*	
	According settings DAY/NIGHT	322*	
332*			
342*			
<b>Internal code from phone</b>	You can dial 1 or 2 numbers of code 2digits code is default You can shorter it by using * on first digit of code during programming	351	
		352	
		361	
		362	
<b>Mode m = 5</b> (parameter 3125)			
<b>Action</b>	<b>Note</b>	<b>Parameter</b>	<b>Relay</b>
<b>Evaluation of correct external code from buttons</b>	According settings DAY/NIGHT	3211-3215	
		3311-3315	
		3411-3415	
	According settings DAY/NIGHT	3221-3225	
		3321-3325	
		3421-3425	
	According settings DAY/NIGHT	321*	
		331*	
		341*	
	According settings DAY/NIGHT	322*	
332*			
342*			
<b>Internal code from phone</b>	You can dial 1 or 2 numbers of code 2digits code is default You can shorter it by using * on first digit of code during programming	351	
		352	
		361	
		362	

mode m = 4			
Action	Note	Parameter	Relay
Button push	Any button different from 311* or 312*	3114	
		3124	
	Button setup by 311* or 312*	3114	
		3124	
Mode m = 6			
Action	Note	Parameter	Relay
Button push	Any button different from 311* or 312*	3116	-
		3126	-
	Button setup by 311* or 312*	3116	
		3126	

Note: t1 – time activation 1 of relay (*parameter 371*)  
t2 – time between pulses 1 of relay (*parameter 301*)  
t3 – time between activation 1 and 2 relay (*parameter 39*)  
t4 – time activation 2 of relay (*parameter 372*)  
t5 – time between pulses 1 of relay (*parameter 302*)

Tab. 1 Table of relay(s) control

## 3.1 Person inside the building

By person inside building we mean a person in the telephone connection with A-Bell doorphone, for example Mr. Nedved.

### 3.1.1 Outgoing call

An outgoing call is a call from the doorphone (generated by a visitor). After the doorphone dials there is ringing a phone inside the building. When you pick up the phone you can talk to the visitor. By code dialling you can activate the relay (*parameter 35*) - when relay is setup in mode m=1 or m=5. You also can switch operation mode DAY/NIGHT (*parameter 45,46*) and hang up (*parameter 43*). The doorphone sends 10sec before call ending (*parameter 52*) alerting tone and you can extend the call by dialling a special character from the phone (*parameter 42*). By phone hanging up the call is ended (PBX generates a busy tone into the line which is detected and the doorphone hangs up). There is one more option – you can hang up the line by repeated pressing of the same pushbutton (*parameter 4\**).

### **3.1.2 Incoming call**

An incoming call is a call into the doorphone (generated by a person inside the building). After dialling an extension number to which the doorphone is connected, the doorphone's line is ringing. After pre-programmed number of rings the doorphone picks up (*parameter 51*) and you can talk. Other possibilities are the same as in the case of an outgoing call (chapter 3.1.1).

- The first exception are the first 10sec where you can dial "# and service password" (*parameter 44*). It allows you to enter into the programming mode of the doorphone.
- The second exception is when DIP1 is switched to position ("SERVIS"). Then you enter into the programming mode directly without dialling the service password.
- The last exception is the relay(s) control (*parameter 381 and 382*). By programming you can prohibit controlling relay(s) from an incoming call.

## 4 Parameters programming

---

### 4.1 Programming by phone

#### 4.1.1 Entering into programming

You can enter programming mode by the following ways:

1. **password** – incoming call only! – pick up the phone and dial phone number where the doorphone is connected (*either extension number when the doorphone is connected to PBX or PSTN line number of building where the doorphone is connected and let operator connect you to an appropriate door phone extension*). The doorphone picks up (you hear pick up acoustic tone – see chapter 3.1) and you have to dial within 10 sec **#xxxx**, where **xxxx** is a service password to enter into the programming mode (**default xxxx=0000**). When all is correct you hear an acoustic tone of the programming mode enter and after a while you can hear the programming tone (see chapter 3.1).
2. **switch "SERVIS"** – incoming call only! – the connection you establish the same way as in point 1. However only when the DIP1 switch is in position "on". Then after the doorphone picks up, it is going into the programming mode directly without necessity to insert the service password. (see chapter 3.1).

#### 4.1.2 Parameters programming

Standby stage of programming is announced by a programming tone into which the doorphone always returns after a time-out (5sec) whenever you start programming.

There are two kinds of parameters you can program. The first one are parameters with a **fix length** – most of parameters are those. The parameter is saved immediately after inserting a mandatory length – you can hear a **confirmation tone**. The second one are parameters with a **variable length** (*parameter 1, 2, 32, 33, 34*). Saving and confirmation of those parameters is made 5 seconds after inserting the last dial. There is one case when those parameters are saved immediately and it is filling up a maximum number of characters (numbers) – at *parameter 1 and 2* it is 24, *parameter 32, 33, 34* it is 6.

When during the programming there is inserted a number (character) which is unacceptable then the doorphone sends an **error tone**. The parameter is not saved or even changed. The doorphone returns to a standby and you can start again the parameter programming and program other parameters.

When you enter into the programming mode and do not make any dialling for a time period of 30 seconds, the doorphone will hang up. After each dialled DTMF tone the time is prolonged by 30 seconds. You can finish programming mode also by dialling *parameter 9*.

## 4.2 PC programming – BellSet program

For PC programming of the doorphone you need to purchase a special PC USB programming cable USB-KAB (item No. 212124) and you the program BellSet (freely available on every attached CD). Then you have to connect the doorphone to the line or in version **/C** or **(C)** switch ON and connect a power supply 12V - DIP3 and 4.

### Procedure:

- Connect the telephone line into the doorphone or in version **/C** and **(C)** you can use an external power supply 12V (DIP 3, 4)
- Connect the special USB cable to a PC USB socket. The doorphone picks up the line within 3 seconds and plays a tone of entering into programming (see chapter 3.1).
- Run program BellSet. The doorphone enters into the programming mode any time when the BellSet program is running. The doorphone stays pasive until you disconnect the USB cable. When you lose the connection please disconnect the USB cable from the doorphone and connect it again – the doorphone picks up.
- Correct connection of the PC with the BellSet program is indicated by reading firmware version from the doorphone (visible in bar) and also by reading the time (shown in left top corner). When you have version **(LC)** then time is 0 because the LC version does not include the RTC circuit.

For easy orientation the parameters in the BellSet program are marked by the same codes as codes for programming by phone.

Details about setting can be found in HELP program.

The USB cable is a special cable with a galvanic isolation and with 3V convertor. The galvanic isolation is necessary because the telephone line must not be grounded and PCs are usually grounded.

## 5 Description of programmable parameters

Parameters always start by a fixed, mandatory part (address) and a variable part – it is your dialling. Range and explanation is always under each table. All is dialled as it is written in the table. You don't dial any confirmation character. After saving into the memory you get back a confirmation tone. When the dialled value is incorrect you get an error tone immediately.

### 5.1 Direct numbers dial – memories

Parameter	Value	description	Default
1	tt nn...	Number nn under button tt	-

**tt** – button number (memory), always has got 2 digits [01-99]

**nn** – phone number up to 24 digits which you wish to save. For saving further characters use assignments mentioned in the table.

Numbers saved in the parameter 1 are numbers of the **first group**, or numbers of the **DAY mode**.

Default settings neither erase nor change saved numbers.

description	dial
0 - 9	0 - 9
#	#
*	**
Flash	* #
Pause	* 0

Parameter	Value	Description	Default
2	tt nn...	number nn under button tt	-

**tt** – button number (memory), always has 2 digits [01-99]

**nn** – phone number up 24 digits which you desire to save. For saving further characters use assignments mentioned in table.

Numbers saved in parameter 1 are numbers of **second group**, or numbers of **NIGHT mode**.

Default settings neither erase nor change saved numbers.

description	Dial
0 - 9	0 - 9
#	#
*	**
Flash	* #
Pause	* 0

**Note:** switching DAY/NIGHT mode stays in doorphone even after line disconnection and version (C) this mode switch up current time (when this feature is activated - parameter 084)

**Note:** the version of doorphone **A-Bell- C** and **A-Bell- LC** has got max. 2 pushbuttons in the standard version - tt=01-02. You can connect up to 12 additional expansion modules Bell-8 and reach a maximum number of pushbuttons  $96 + 2 = 98$  pushbuttons in total.



### Settings examples:

1. the first button should dial at DAY number 358 and at NIGHT 0\_603441296 , you program it - 101358 and wait for ♪, next 2010 \*0 603441296 and wait for ♪
2. the second button should dial at DAY and at NIGHT 123#1\*2Flash3, you program 102123#1 \*\* 2 \*# 3 and wait for ♪, next 202123#1 \*\* 2 \*# 3 and wait for ♪

**Note:** When you don't use mode of 2 group numbers or DAY/NIGHT mode we recommend to setup DAY/NIGHT mode (*parameter 47*) and then setup the same code for DAY/NIGHT switching (*parameters 45 and 46*). You provide by this that the doorphone will be always in the DAY mode and then you program numbers for the DAY mode only (*parameter 1*).

## 5.2 Relays

Parameter	Value	Description	Deafault
31	r m	relay r works in mode m (1-8)	11 21

r – relay number [1-2]

m – relay mode [1-8 for r=1 is not mode m=5]

modes **m=1,4,5,6** are detailedly described in *Note: t1 – time activation 1 of relay (parameter 371)*

t2 – time between pulses 1 of relay (*parameter 301*)

t3 – time between activation 1 and 2 relay (*parameter 39*)

t4 – time activation 2 of relay (*parameter 372*)

t5 – time between pulses 1 of relay (*parameter 302*)

. on page 28

**m=1** mode **relay** – activated by command (internal code) or password (external code) 1 pulse for time t1/t4 (using for electrical locks) or 2 pulses when is activated for time t1/t4, open for time t2/t5 and close for time t1/t4 (sliding door opening)

**m=2** closed for time of line OFF HOOK (**camera**) – close when the doorphone picks up and open by hanging up

**m=3** closed for time of line OFF HOOK and more for time t1/t4 after hang up (**lighting**) – closed when the doorphone picks up and stays closed for time t1/t4 after the doorphone hangs up (for this time line is busy, at version /C and C is after switching DIP 3,4 and settings *parameter 64* for time t1/t4 line hanged up)

**m=4** mode **button** – closed when any button is pushed and open after time t1/t4 (usage for example: connection of an external bell)

**m=5** mode **progressive opening** – you can setup into this mode relay 2 only because relay 1 will be setup automatically into mode m=1. By command (internal code) or password (external code) is activated relay 1 for time t1, then is running time t3 before closing relay 2. Then relay 2 is activated for time t4 and then the doorphone hangs up. When dialled command or password match to 2 pulses then in sequence will appear two pulses separated by time t2/t5. Explained in *Note: t1 – time activation 1 of relay (parameter 371)*

- t2 – time between pulses 1 of relay (*parameter 301*)
- t3 – time between activation 1 and 2 relay (*parameter 39*)
- t4 – time activation 2 of relay (*parameter 372*)
- t5 – time between pulses 1 of relay (*parameter 302*)

**Note.** The command or password for relay 1 starts the whole sequence. When you use command or password for relay 2 then you control relay 2 only the same way as in mode m=1.

- m=6 closed up pushed button (setup in parameter 31r\*). Thanks to this you can select **one button** for every relay its pushing activate appropriate relay for time t1/t4. This mode serves as substitution of a ring bell connected to A-Bell system.
- m=7 **permanent closing** / opening – usable at versions **IC** and **(C)** only, if switching (DIP 3,4)+par.64. By command for pulse 1 is closed and for pulses2 is opened. This stage stays in doorphone even after power/line disconnection. This mode you can use for potting, glasshouse opening, heating activation etc..
- m=8 activated **up DAY/NIGHT mode settings** – can be used in versions **IC** and **(C)** only, if switching (DIP 3,4)+par.64. Version **IC** allows copying manual DAY/NIGHT switching only. Version **(C)** allows copying setting from week table switching time (when is activated - *parameter 084*) and then you can use for example for heating control etc.

Parameter	Value	Description	Default
31	r* tt	button tt start relay closing r in mode m=6 (01-99)	01

r – relay number [1-2]

tt – button number (memory), always has 2 digits [01-99]

This parameter is for relay mode m=6 only. Value of tt designate from which button start closing for time t1/t4 of relay r.

Parameter	Value	Description	Default
32	rp hh...	In mode <b>DAY + NIGHT</b> password hh... for relay r, in order p=1-5, for 1 pulse and p=* for 2 pulses (00-999999)	-
33	rp hh...	In mode <b>DAY</b> password hh... for relay r, in order p=1-5, for 1 pulse and p=* for 2 pulses (00-999999)	-
34	rp hh...	In mode <b>NIGHT</b> password hh... for relay r, in order p=1-5, for 1 pulse and p=* for 2 pulses (00-999999)	-

r – relay number [1-2]

p – order [1 - 5] for 1 pulse. 5 passwords (external codes) from doorphone buttons (external code of code lock)

**p** – order = \*, then you can insert just one code (external code) for closing by 2 pulses

**hh...** – password (external code) for relay closing from buttons [2 to 6 digits]. Pushbuttons 1 - 10 are programmable as numbers 1-0.

Totally 3 x 12 passwords. Controlled by settings DAY/NIGHT. Combination is inserting by doorphone buttons. Relay closing is influenced by setup relay **mode** and switching **DAY/NIGHT**. When is setup mode **2 groups of numbers** the doorphone is permanently in mode **DAY**.

You have to keep certain rules for password dialling:

- First button of password select from at least used button for direct dialling (-prolong dial time)
- Caution on numbers identical to the password. When one password includes other, for example: password for relay1 is 1234 and for relay 2 12345, then always after pushing button 4 relay 1 will be activated and relay 2 wont be never activated. When you select password for relay 2 234, then after button 4 pushing both relays will be activated.

**Note1.** switching to DAY/NIGHT mode stays setup in doorphone even after power (line) disconnection. At version **(C)**, when is activated, then DAY/NIGHT switching is done up time and week table.

**Note2.** when you insert parametres **32,33,34** do not use character # and \* because you can't select them from button panel. Number 0 represents button 10.

Parameter	Value	Description	Default
<b>35</b>	<b>r aa</b>	command <b>aa</b> from phone for relay activating r 1 pulse (00-99,*0-*9)	155 266

**r** – relay number [1-2]

**aa** – command (internal code) from phone for relay activation [2 digits] /<sup>1</sup>

For both relays you can setup the same command (internal code) then both relays are activated simultaneously. It is profitable to setup the same command for relay activation as same as doorphone hang up (*parametr 43*) **aa=bb**.

/<sup>1</sup> – command has always 2 digits but when you want control relay by **1 digit** only ( from keypad of phone) then you have possibility to programm " \***a** " where **a** is one number only which activate the relay (star represents empty character and must be on first digit position).

Example: 1 relay activated by internal code 48 - dial **35148** ♪

2 relay activated by internal code 8 - dial **352\*8** ♪

By dialling on phone 8 you activate relay 2 by dialling 48 you activate both relays

Parameter	Value	Description	Default
<b>36</b>	<b>r cc</b>	command <b>aa</b> from phone for relay activation r 2 pulses (00-99,*0-*9)	150 260

**r** – relay number [1-2]

**cc** – command (internal code) from phone for relay activation [2 digits] /<sup>1</sup>

For both relays you can setup the same command (internal code) then both relays are activated simultaneously.

/<sup>1</sup> – command has always 2 digits but when you want control relay by **1 digit** only ( from keypad of phone) then you have possibility to programm " \*a " where **a** is one number only which activate the relay (star represents empty character and must be on first digit position).

Activation relay 2 pulses is suitable for example: at sliding gate which this way can also substitute wicket for person entrance.

Example: command to activate relay1 with 1 pulse \*8, command to hang up \*8 and command for activation relay2 with 2 pulses \*9.

Dial: 352\*8 ♪ , 432\*8 ♪ , 362\*9 ♪.

You are in communication with the doorphone unit. Dial command for open sliding gate 9. First pulse starts sliding the gate and second pulse stop it. The size of spot for person entrance is according time between each pulses (*parameter 30*). After person entering you dial 8. The doorphone makes one pulse and hang up. Sliding gate is closing.

Parameter	Value	Description	Default
37	r ss	time ss [sec] activation relay r for time t1/t4 (01-99)	105 205

r – relay number [1-2]

ss – time t1 / t4 for which is relay closed 1 / 2 [2 digits 00-99], where time 00 means 0,5sec

Parameter	Value	Description	Default
38	r p	Control relay r during incoming call (0/1)	11 21

r – relay number [1-2]

p – parameter which says permitted p=1 or forbidden p=0 control relay during incoming call

To prohibit control of relay during incoming call makes sense for example by relay2 in mode 1 by which you control thesliding gate opening where the doorphone opens the gate and after car's passing the gate is closed. Then control by phone could make unwillingly permanent gate opening.

Parameter	Value	Description	Default
39	xx	time xx [sec] between activation relay 1 and 2 in mode m=5 - time t3 (01-99)	10

**xx** – time t3 between activation relay 1 and 2 when mode **m=5** is setup (progressive opening) [2 digits 00-99] , when time 00 means 0,5sec

Parameter	Value	Description	Default
<b>30</b>	<b>r zz</b>	time <b>zz</b> [sec] between pulses when is closing for 2 pulses relay <b>r</b> - time <b>t2/t5</b> (01-99)	105 205

**r** – relay number [1-2]

**zz** – time t2 / t5 between first and second pulse relay activation 1 / 2 [2 digits 00-99], where 00 means 0,5sec

### 5.3 Basic parameters

Parameter	Value	Description	Default
<b>41</b>	<b>v</b>	Dial type <b>v</b> – tone / pulse (0/1)	0

**v** – dial type **v=0** is DTMF tone dial, **v=1** pulse dial

Parameter	Value	Description	Default
<b>42</b>	<b>z</b>	Character to prolong the call (* / #)	*

**z** – character to prolong the call \* or # (10sec before call termination doorphone sends notification then you can prolong the call)

Parameter	Value	Description	Default
<b>43</b>	<b>g bb</b>	Command to hang up doorphone by phone (00-99,*0-*9)	155 266

**g** – command order [1-2] (they are two to be possibility hang up doorphone when each relay is used)

**bb** – command to hang up doorphone by phone [2 digits] /<sup>1</sup>

It is profitable setup the same command to hang up doorphone as same as activate relay (*parametr 35,36*) **aa=bb** or **aa=cc**

/<sup>1</sup> – command has always 2 digits but if you want use **1 digit** then you have possibility insert " **a** " where **a** is just one number which activate the relay (star represents empty character and must be on first position). (*Example at parameters 35,36*)

Parameter	Value	Description	Default
<b>44</b>	<b>xxxx</b>	Service password (0000-9999)	0000

**xxxx** – service password to enter programming by phone (DTMF)

Parameter	Value	Description	Default
45	dd	Command to switch into <b>DAY</b> mode (00-99,*0-*9)	11
46	nn	Command to switch into <b>NIGHT</b> mode (0099,*0-*9)	10

**dd** – command to switch into **DAY** mode [2 digits] /<sup>1</sup>

**nn** – command to switch into **NIGHT** mode [2 digits] /<sup>1</sup>

/<sup>1</sup> - command has always 2 digits but if you want use **1 digit** then you have possibility to insert " \*a " where **a** is just one number which switch **DAY/NIGHT** mode (star represents empty character and must be on first position).

**Note.** Switching into DAY or NIGHT mode stays setup even after power (line) disconnection from the doorphone

Parameter	Value	Description	Default
47	e	Doorphone dial mode (0/1)	1

**e** – dial numbers mode **e=0** dial numbers from first and second group, **e=1** numbers are dialled up **DAY/NIGHT** mode in doorphone

**CAUTION !!** setting of this parameter has a big influence to numbers dialling

Parameter	Value	Description	Default
4*	k	Feature of line hanging up by again push of the same button (0/1)	1

**k** – line hanging up by pressing the same button:

**k=0** feature is switched off

**k=1** repeated pressing of the pushbutton hangs up the line

**CAUTION !!** setting of this parameter has got a big influence on numbers dialling

## 5.4 Time parameters

Parameter	Value	Description	Default
51	q	Number of rings before doorphone picks up incoming call (1-9)	2

**q** – number of incoming call rings . The doorphone picks up between rings and 2 sec after detection of **q** – th rings. Number is adjustable from 1 to 9.

Parameter	Value	Description	Default
52	d	Maximal call duration (0-9,*,#)	2

**d** – maximum time for which the doorphone is OFF HOOK. This time period you can prolong by dialling a character during a call by phone (\* or # - parameter 42). Setting of the time period is shown in the table.

time[min]	Dial
0,5	0
1 - 9	1 - 9
15	*
30	#

Parameter	Value	Description	Default
53	w	Time period between button push (1-9)	2

**w** – maximum time [sec] between button push [range 1-9]

- **normal buttons**
- **relay activation** – when time between push of 2 following buttons is longer than time **w** then the code is evaluated incorrectly.
- **Number dial** – when button which we push is the first number in the password for relay activation then dialling is delayed by this time period **w**

Parameter	Value	Description	Default
<b>54</b>	<b>z</b>	Hanging up time during REDIAL (1-5)	2

**z** – time [sec] for which doorphone hangs up before pick up for REDIAL (button push during call, busy tone detection) [range 1-5]

Parameter	Value	Description	Default
<b>55</b>	<b>z</b>	Time before start dialling (1-5)	1

**z** – time [sec] after doorphone picks up and before it starts dialling [range 1-5].

This time is different for every PBX but usually all PBXs accept dialling within 2 seconds after the line is picked up.

Parameter	Value	Description	Default
<b>56</b>	<b>hh</b>	Number of rings before hang up (04-99)	12

**h** – after dial termination calculate number of CRT (control ring tones). When number is higher than **hh** then hang up [range 04-99]. Dial is repeated in case of 2 groups mode.

Parameter	Value	Description	Default
<b>500</b>	<b>x</b>	Middle frequency of tones detector (1-0)	3 (375-475Hz)
<b>501</b>	<b>y</b>	Number of busy tones (2-0)	4
<b>502</b>	<b>z</b>	Time of permanent tone duration (1-5)	3 (3s)

**x** – middle frequency of tones detector – it is suitable when the signalling of PBX is unusual:

frequency [Hz]	x - dial
275-375	1
325-425	2
375-475	3
425-525	4
475-575	5
525-625	6
575-675	7
625-725	8
675-775	9
725-825	0

**y** – minimal number of busy tones necessary for detection [2-0], where 0 means 10 busy tones

**z** – minimal time of permanent tone duration (for dial tone detection on PBX) [1-5 sec]



Parameter	Value	Description	Default
503	tt	Time of tone duration DTMF (tone) dial (04-16)	10 (100ms)
504	mm	Time of space duration between DTMF tones (04-16)	10 (100ms)
505	f	Time of Flash duration (1-6)	1 (100ms)
506	p	Time of pause duration / pause between numbers (1-0)	4 (800ms)

**tt** – Time of tone duration DTMF (tone) dial is calculated up:

$$(inserted\ number) \times 10 = \text{tone duration time [ms]}$$

[range 04-16 tj. 40-160ms]

**m** – Time of space duration between DTMF tones is calculated up:

$$(inserted\ number) \times 10 = \text{pause duration time [ms]}$$

[range 04-16 tj. 40-160ms]

**f** – Time of Flash duration is calculated:

$$inserted\ number \times 100 = \text{Flash duration time [ms]}$$

[range 1-6 tj. 100-600ms]

**p** – Time of pause duration is calculated:

$$inserted\ number \times 100 + 400 = \text{pause duration time [ms]}$$

[range 1-0 tj. 500-1400ms]

– time **p** is also time of pause between numbers at pulse dialling

Parameter	Value	Description	Default
507	uu	Level of sending tone DTMF dial in [-dBm](04-16)	10

**uu** – level of sending tone (DTMF) dial into line, range is -4 to -16dBm. You insert desired level, uu=04 is -4dBm, uu=10 is -10dBm

Parameter	Value	Description	Default
508	p	preemphasis DTMF (0/1)	0
509	S	Listening –in DTMF - level (1-4)	2

**p** – preemphasis is rate between upper and lower groups of DTMF frequency.

You can select rate 2,2 dB - p=0 (Europe) or rate 3,2dB - p=1 (Australia)

**s** – listening –in DTMF level you can select in four levels:

Level of listening in DTMF [dB]	s - dial
-15	1
-9	2
-3	3
+3	4

## 5.5 System parameters

Parameter	Value	Description	Default
<b>61</b>	<b>z</b>	Acoustic signalling (confirmation, error, empty memory, call termination...) (0/1)	1

In default the stages of the doorphone are acoustically signalling. By parameter „z“ you can switch off this signalling. Possible values are

z=0 – signalling is off

z=1 – signalling is on

Parameter	Value	Description	Default
<b>62</b>	<b>v</b>	Acoustic signalling off hook/on hook (0/1)	1

In default it is signalling pick up and hang up of the line. If you identify some problems at certain PBXs you can switch it off by parameter „v“ . The possible values are:

z=0 – signalling OFF HOOK / ON HOOK is off

z=1 – signalling OFF HOOK / ON HOOK is on

Parameter	Value	Description	Default
<b>63</b>	<b>u</b>	Acoustic signalling knocking to call (0/1)	0

In default it is switch off. By activation of this feature you can identify at PBX calling from the doorphone just up knocking into call. Possible values are:

u=0 – knocking to call is off

u=1 – knocking to call is on

Parameter	Value	Description	Default
<b>64</b>	<b>w</b>	Powering from external power supply 12V (DIP 3,4) (0/1)	0

In version /C only or at version (C) .

In default an external power supply is OFF.

Activation makes sense only in cases when the doorphone should make some operation during a stand-by mode – relay activation. Relay in mode **m=7** allows permanent closing even after call termination. Relay mode **m=8** allows activation up DAY/NIGHT mode settings even after call termination. In those cases you have to provide an external power supply to avoid flow current at hanged up line. The DIP switch 3 and 4 must be in position „on“ to activate this parameter **w=1** . Deactivation - **w=0**.

Parameter	Value	description	Default
65	z	Acoustic signalling of relay activation (0/1)	0

In default the activation is off **z=0**. Usually you can use this feature for DC power supply 12V. Then when el.lock is released you don't hear „buzzing“ so visitor doesn't know that the el.lock is released. When you activate this feature **z=1** then during relay activation you can hear special sounds simulating relay activation.

**Note.1** This feature is available for relay mode **m=1, m=5** only.

**Note.2** For relay activation with 2 pulses the acoustic signalling sounds during whole time of sequence. (even in space between pulses)

Parameter	Value	Description	Default
66	i	Suppression of DTMF reception from microphone (0/1)	0

In default the suppression of DTMF reception from MIC is off **i=0**. Thanks to this you can activate relay by personal dialler without ringing to person inside building. To increase security you can activate suppression of DTMF reception from microphone **i=1** and thus protect entrance of persons who provided record of DTMF code for door opening.

Parameter	Value	Description	Default
67	b	BabyCall – call without necessity programm phone number (0/1)	0

In default is switch off **b=0**. By activation this feature **b=1** is cancelled acoustic signalling of empty memory. After pushing of button with empty memory you get just beep (confirmation) and call is established as normal dialled number

**Caution:** first 10sec of call is not active tone detector (it waits on reaction of PBX and number dialling by PBX)

Parameter	Value	Description	Default
<b>6*</b>	<b>t</b>	delay start for PBX's with line testing (Siemens) (0/1)	0

In default is switch off **t=0**. By activation this feature **t=1** is processor going to „sleep mode“ after line connection and after 3sec the doorphone makes initialization. It delays line picks up after line ( voltage) connection – activation status / PBX restart. When this feature is not efficient and PBX still evaluate the line into „failure“ mode“ then you have to use external power supply – put **DIP** switch **3** and **4** to position "**on**" – possible at version **/C (C)** only. It is the same like using **Best Box** option.

## 5.6 HandsFree parameters setting

Parameter	Value	Description	Default
71	gg	Reception loudness 01-16 (16 is highest) (TRH)	07
72	ff	Transmission loudness 01-16 (16 is highest) (MIC)	07
73	rr	Speaker loudness 01-16 (16 is highest) (SPK)	07

**gg / ff / rr** – numbers are inserted always by 2 digits in range [01-16]

After reception of confirmation 🎵 is new value immediately active and you can test it.

Help: except inserting of direct values 01-16 you can add/ decrease amplification +/- by buttons on phone \* = - and # = +

Limits of maximal and minimal loudness are acoustically signalling (3 tones as call termination signalling). When you dont press any digit within 5sec then setup value is saved and you hear confirmation tone 🎵.

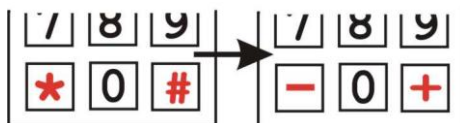

**CAUTION !!** We dont recommend factory setting if necessary.

Parameter	Value	Description	Default
74	c	Soft pass of switching (0/1)	0

In default this feature is off **c=0**. It is going about character of on line operation semiduplex switching. In case where character of depresser is too steep you can make it softer by **c=1**.

Parameter	Value	Description	Default
75	n	Depression of background sound (0/1)	0

In default it is off **n=0**. When the doorphone is installed in a noisy environment (noisy streets, subway stations, parkings...) then by activation of this circuit **n=1** is setup level of noise as start level for microphone activation. Then the call connection is not one way opened. It relates with setup of parameters 71, 76, 77.

Parameter	Value	Description	Default
76	b	Level of microphone start 1-4 (4 is highest)	3

On the line is simultaneously signal from microphone and speaker. In handsfree circuit there are a few functional blocks to suppress acoustic shock. The basic one is a circuit of semiduplex operation when an incoming signal decreases microphone amplification as well as the signal from microphone decreases an incoming signal. The level of microphone start is setup by this parameter. The lower value the higher microphone sensitivity is. In noisy environment we recommend higher value with a combination of parameters 71,75, 77.

Parameter	Value	Description	Default
77	s	Fast switching voice automatic 1-4 (4 is slowest)	2

At parameters 75, 76 is described principal of acoustic shock suppression. Speed of circuit switching between incoming and outgoing sound is setup by parameter 77.

Switching time [ms]	S - dial
1	1
2	2
4	3
8	4

Parameter	Value	Description	Default
78	I	VoltAmper (VA) characteristic of line connection (0/1)	1

Almost every country around the world has got different telephone directives and this parameter allows decreasing voltage at the doorphone line interface about 1V during OFF HOOK. Where directive requires decreasing of line voltage  $I=0$  decrease voltage about 1V. In default  $I=1$ .

Parameter	Value	Description	Default
79	k	Compensation of wires losses depends on line current (0/1/2)	0

The doorphone A-Bell includes a circuit which can compensate losses on wiring during long distance installations (100m and more from PBX). In default the feature is off **k=0**. You can setup in two levels depending on line current of PBX (short circuit current  $I_0$ ).

PBX current $I_0$	k - dial
Feature is off	0
20mA-50mA	1
45mA-75mA	2

Parameter	Value	Description	Default
70	uu	Transmission signalling level in [-dBm] (04-16)	10

**uu** – transmission signalling level to the line, range -4 to -16dBm. You insert desired level, uu=04 is -4dBm, uu=10 is -10dBm ...

## 5.7 Time program – automatic DAY/NIGHT switching (C)

### (C) version only !

Parameter	Value	Description	Default
<b>09</b>	<b>a</b>	ON / OFF automatic DAY/NIGHT switching and setting time control (0/1/#)	<b>0</b>

When the doorphone A-Bell includes RTC circuit - **(C)** version then you can activate automatical switching from real time **a=1**. The condition is correct time settings. You can verify it easily by dialling **a=#** and doorphone reply either by confirmation tone (all is correct) or error tone (you have to setup the time). By dial **a=0** you deactivate automatical switching.

Parameter	Value	Description	Default
<b>081</b>	<b>hhnn</b>	Time settings hh-hours, nn-minutes	-
<b>082</b>	<b>ddmmyyw</b>	Date settings dd-day, mm-month, yy-year, w-weekday	-
<b>083</b>	<b>#</b>	wait 1 min for seconds zeroing	-

Internal clocks parameters setting. After setting by command **083#** zeroing seconds setting any through this agreed clocks exactly up seconds.

w - weekday: 0 - Sunday  
 1 - Monday  
 2 - Tuesday  
 3 - Wednesday  
 4 - Thursday  
 5 - Friday  
 6 - Saturday

**Example:** if you wish to set 27.5.2011 9:39 (it is Friday), then dial sequence: 0822705115 you hear tone ♪, then dial 0810939 hear tone ♪ and finally dial 083 – wait for exact time sec=0 . In this moment dial # and you hear tone ♪ - finished.



Parameter	Value	Description	Default
00	hhnnkkjj	<b>Sunday</b> – time setting hours <b>hh</b> and minutes <b>nn</b> starts <b>day</b> and hours <b>kk</b> and minutes <b>jj</b> starts <b>night</b>	00000000
01	hhnnkkjj	<b>Monday</b> - time setting hours <b>hh</b> and minutes <b>nn</b> starts <b>day</b> and hours <b>kk</b> and minutes <b>jj</b> starts <b>night</b>	00000000
02	hhnnkkjj	<b>Tuesday</b> - time setting hours <b>hh</b> and minutes <b>nn</b> starts <b>day</b> and hours <b>kk</b> and minutes <b>jj</b> starts <b>night</b>	00000000
03	hhnnkkjj	<b>Wednesday</b> - time setting hours <b>hh</b> and minutes <b>nn</b> starts <b>day</b> and hours <b>kk</b> and minutes <b>jj</b> starts <b>night</b>	00000000
04	hhnnkkjj	<b>Thursday</b> - time setting hours <b>hh</b> and minutes <b>nn</b> starts <b>day</b> and hours <b>kk</b> and minutes <b>jj</b> starts <b>night</b>	00000000
05	hhnnkkjj	<b>Friday</b> - time setting hours <b>hh</b> and minutes <b>nn</b> starts <b>day</b> and hours <b>kk</b> and minutes <b>jj</b> starts <b>night</b>	00000000
06	hhnnkkjj	<b>Saturday</b> - time setting hours <b>hh</b> and minutes <b>nn</b> starts <b>day</b> and hours <b>kk</b> and minutes <b>jj</b> starts <b>night</b>	00000000
07	#	overwrite (copyright) setting from Sunday (00) into whole week	-

By parameters 00-06 are setting times of automatic switching DAY/NIGHT for every day in week. The parameter 07 is designed for copying when setting is the same for the whole week. Then you setup switching times for parameter 00 (sunday) and then by parametr 07# you copy this setting into remaining days.

**Examples:**

1. Monday 8:00 starts day, 17:05 starts night, Tuesday 7:30 starts day and in 16:00 starts night.

*Setting sequence:* 0108001705 and 🎵, then 0207301600 and 🎵

2. In Thursday starts day 6:45 and night starts 15:05, on Friday night continue until 15:00 and then starts day and it is until saturday 12:00 , then is night. Here you can use setting of switching inside one day into night even night is still valid from previous day and again switching into day even day is valid from previous day. Then for setting after midnight you insert time 00:00.

*Setting sequence:* 0406451505 and 🎵, 0515000000 and 🎵, 0600001200 and 🎵

## 5.8 Default setting and erasing

Parameter	Value	Description	Default
8#	#	Default	execute

This setting does not change parameters 1 and 2 (numbers saved in memories)

Parameter	Value	Description	Default
81		Erase all numbers in group 1 (Day mode)	
82		Erase all numbers in group 2 (Night mode)	
83		Default settings for parametres 3x only	3 only..
84		Default settings for parametres 4x only	4 only..
85		Default settings for parametres 5x only	5 only..
86		Default settings for parametres 6x only	6 only..
87		Default settings for parametres 7x only	7 only..
80		Default settings for parametres 0x only	0 only..

Parameters 81 and 82 makes erasing of all numbers saved in button memories.

Parameters 83 – 87,80 makes default settings for parameters starts 3,4,5,6,7,0 only. Default settings values are mentioned at every parameter in right - column "Default".

**CAUTION !!!** the erasing is irreversible!!! it is necessary to program again

## 5.9 Programming termination

Parameter	Value	Description	Default
9		E N D of programming	

After 9 dial in programming tone the doorphone hangs up.

## 5.10 Overview of parameters

Parameter	Value	Description	Default
1	tt nn...	number nn under button tt	-
2	tt nn...	number nn under button tt	-
31	r m	relay r works in mode m (1-8)	11 21
31	r* tt	button tt activate relay closing r in mode m=6 (01-99)	01
32	rp hh...	In mode <b>DAY + NIGHT</b> password hh... for relay r, in order p=1-5, for 1 pulse and p=* for 2 pulses (00-999999)	-
33	rp hh...	In mode <b>DAY</b> password hh... for relay r, in order p=1-5, for 1 pulse and p=* for 2 pulses (00-999999)	-
34	rp hh...	In mode <b>NIGHT</b> password hh... for relay r, in order p=1-5, for 1 pulse and p=* for 2 pulses (00-999999)	-
35	r aa	command aa from phone for closing relay r 1 pulse (00-99,*0-*9)	155 266
36	r cc	command aa from phone for closing relay r 2 pulses (00-99,*0-*9)	150 260
37	r ss	time ss [sec] relay closing r for time t1/t4 (01-99)	105 205
38	r p	Relay control r during incoming call (0/1)	11 21
39	xx	time xx [sec] between relay closing 1 and 2 in mode m=5 - doba t3 (01-99)	10
30	r zz	time zz [sec] between pulses during closing for 2 pulses of relay r - doba t2/t5 (01-99)	105 205
41	v	Dial type v – tone / pulse (0/1)	0
42	z	Character for call prolongation (* / #)	*
43	g bb	Command to hang up doorphone by phone (00-99,*0-*9)	155 266
44	xxxx	Service password (0000-9999)	0000
45	dd	Command to switch into <b>DAY</b> (00-99,*0-*9)	11
46	nn	Command switch into <b>NIGHT</b> (0099,*0-*9)	10
47	e	Doorphone dial mode (0/1)	1

<b>4*</b>	<b>k</b>	Feature of line hanging up by again push of the same button (0/1)	1
<b>51</b>	<b>q</b>	Number of rings before doorphone pick up incoming call (1-9)	2
<b>52</b>	<b>d</b>	Maximal call duration (0-9,*,#)	2
<b>53</b>	<b>w</b>	Time between button push (1-9)	2
<b>54</b>	<b>z</b>	Hang up time before REDIAL (1-5)	2
<b>55</b>	<b>z</b>	Time before dial start (1-5)	1
<b>56</b>	<b>hh</b>	Number of ringing before hang up (04-99)	12
<b>500</b>	<b>x</b>	Middle frequency of tone detector (1-0)	3 (375-475Hz)
<b>501</b>	<b>y</b>	Number of busy tones (2-0)	4
<b>502</b>	<b>z</b>	Duration time of permanent tone (1-5)	3 (3s)
<b>503</b>	<b>tt</b>	Duration time of tone DTMF of tone dial (04-16)	10 (100ms)
<b>504</b>	<b>mm</b>	Time of space between each DTMF tones (04-16)	10 (100ms)
<b>505</b>	<b>f</b>	Flash duration time (1-6)	1 (100ms)
<b>506</b>	<b>p</b>	Pause duration time / space between numbers (1-0)	4 (800ms)
<b>507</b>	<b>uu</b>	Transmitting level of DTMF dial in [-dBm] (04-16)	10
<b>508</b>	<b>p</b>	preemphasis DTMF (0/1)	0
<b>509</b>	<b>S</b>	Listening in DTMF – level (1-4)	2
<b>61</b>	<b>z</b>	Acoustic signalling (confirmation,error, empty memory, call termination...) (0/1)	1
<b>62</b>	<b>v</b>	Acoustic signalling OFF HOOK /ON HOOK (0/1)	1
<b>63</b>	<b>u</b>	Acoustic signalling of beeping into call (0/1)	0
<b>64</b>	<b>w</b>	External powering from power supply 12V (DIP 3,4) (0/1)	0
<b>65</b>	<b>z</b>	Acoustic signalling of relay activation (0/1)	0
<b>66</b>	<b>i</b>	Depression of DTMF reception from microphone (0/1)	0
<b>67</b>	<b>b</b>	BabyCall – call without necessity to insert phone number (0/1)	0
<b>6*</b>	<b>t</b>	Delay start for PBX's with extension test (Siemens) (0/1)	0

71	<b>gg</b>	Reception loudness 01-16 (16 is highest) (TRH)	07
72	<b>ff</b>	Transmission loudness 01-16 (16 is highest) (MIC)	07
73	<b>rr</b>	Speaker loudness 01-16 (16 is highest) (SPK)	07
74	<b>c</b>	Soft pass of switching (0/1)	0
75	<b>n</b>	Depression of background sound (0/1)	0
76	<b>b</b>	Level of microphone start 1-4 (4 is highest)	3
77	<b>s</b>	Fast switching voice automatic 1-4 (4 is slowest)	2
78	<b>l</b>	VoltAmper (VA) characteristic of line connection (0/1)	1
79	<b>k</b>	Compensation of wires losses depends on line current (0/1/2)	0
70	<b>uu</b>	Transmission signalling level in [-dBm] (04-16)	10
09	<b>a</b>	ON/ OFF automatic switching DAY/NIGHT mode and time settings control (0/1/#)	0
081	<b>hhnn</b>	Time settings hh-hours, nn-minutes	-
082	<b>ddmmyy</b>	Date settings dd-day,mm-month,yy-year	-
083	<b>#</b>	Wait for 1 min for seconds zeroing	-
00	<b>hhnnkkjj</b>	<b>sunday</b> - time setting hours <b>hh</b> and minutes <b>nn</b> starts <b>day</b> and hours <b>kk</b> and minutes <b>jj</b> starts <b>night</b>	00000000
01	<b>hhnnkkjj</b>	<b>monday</b> - time setting hours <b>hh</b> and minutes <b>nn</b> starts <b>day</b> and hours <b>kk</b> and minutes <b>jj</b> starts <b>night</b>	00000000
02	<b>hhnnkkjj</b>	<b>tuesday</b> - time setting hours <b>hh</b> and minutes <b>nn</b> starts <b>day</b> and hours <b>kk</b> and minutes <b>jj</b> starts <b>night</b>	00000000
03	<b>hhnnkkjj</b>	<b>wednesday</b> - time setting hours <b>hh</b> and minutes <b>nn</b> starts <b>day</b> and hours <b>kk</b> and minutes <b>jj</b> starts <b>night</b>	00000000
04	<b>hhnnkkjj</b>	<b>thursday</b> - time setting hours <b>hh</b> and minutes <b>nn</b> starts <b>day</b> and hours <b>kk</b> and minutes <b>jj</b> starts <b>night</b>	00000000
05	<b>hhnnkkjj</b>	<b>friday</b> - time setting hours <b>hh</b> and minutes <b>nn</b> starts <b>day</b> and hours <b>kk</b> and minutes <b>jj</b> starts <b>night</b>	00000000
06	<b>hhnnkkjj</b>	<b>saturday</b> - time setting hours <b>hh</b> and minutes <b>nn</b> starts <b>day</b> and hours <b>kk</b> and minutes <b>jj</b> starts <b>night</b>	00000000
07	<b>#</b>	overwrite (copyright) setting from sunday	-

		(00) into whole week	
<b>8#</b>	<b>#</b>	default	execute
<b>81</b>		Erase all numbers in group 1 (DAY mode)	
<b>82</b>		Erase all numbers in group 2 (NIGHT mode)	
<b>83</b>		Default setting for parametres 3x only	3 only..
<b>84</b>		Default setting for parametres 4x only	4 only..
<b>85</b>		Default setting for parametres 5x only	5 only..
<b>86</b>		Default setting for parametres 6x only	6 only..
<b>87</b>		Default setting for parametres 7x only	7 only..
<b>80</b>		Default setting for parametres 0x only	0 only..
<b>9</b>		END	

## 6 Technical parameters

### 6.1 Electrical parameters

Parameter	Value	Conditions
Minimum line current	18mA	Line OFF HOOK
Minimum line voltage	18V	Line ON HOOK
Line voltage during OFF HOOK (VA characteristic)	< 8V < 12V <sup>1)</sup>	I = 20mA I = 60 mA
Downlead during ON HOOK	< 30uA	U = 60V
Line termination impedance	220R + 820R paral. 115nF	Line OFF HOOK
Bandwidth	300Hz – 3400 Hz	20 - 60mA
Ringing impedance	> 2Kohm	25 – 60 Hz
Sensitivity of ringing detector	min. 10 – 25 V	
Pulse dial	40 / 60 ms	
Tone dial level	-6 and -8 dB <sup>1)</sup>	20 – 60 mA
Sensitivity of tone dial	min. -40 dB	20 – 60 mA
Sensitivity of tones detector	min. -30 dB	20 – 60 mA
Powering of backlight, relays and heating	12VDC ± 2V , 10-12VAC ± 2V	
Max consumption of backlight and heating	250mA	12Vss
Max voltage of relay contact	48V	when I < 1A
Max current of relay contact	1,5A	when U < 30 V
Operation temperature	-20 to +60 degrees Celsius	
IP rate	IP44	
Weight	max. 350g	
Camera	Parametres on page 21	

<sup>1)</sup> – can be changed by programming

### 6.2 Mechanical dimensions

Item	dimensions HxWxD [mm]
A-Bell- C (1 and 2 pushbuttons)	208 x 99 x 30
Bell-8	208 x 99 x 30
Screw 2x	screw 4x35 half-round headed
Wall plug 2x	UPA,UPP diameter 5 x 40

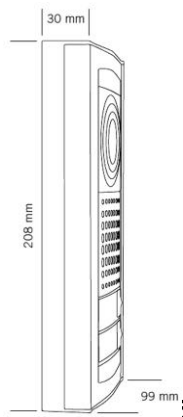

## 7 Table for easy programming

Into the empty parts of the table please write values which you wish to program. In double linked part are mentioned programming commands for easy programming. Moreover the programmed values stay in the manual for future changes.

Description		Programming sequence		digits
description	detail	par.	Fill up your values	
Number under button 1	Day/1gr.	101		24
Number under button 2	Day/1gr.	102		24
Number under button 3	Day/1gr.	103		24
Number under button 4	Day/1gr.	104		24
Number under button 5	Day/1gr.	105		24
Number under button 6	Day/1gr.	106		24
Number under button 7	Day/1gr.	107		24
Number under button 8	Day/1gr.	108		24
Number under button 9	Day/1gr.	109		24
Number under button 10	Day/1gr.	110		24
Number under button 11	Day/1gr.	111		24
Number under button 12	Day/1gr.	112		24
1 Number under button	Night/2gr	201		24
2 Number under button	Night/2gr	202		24
3 Number under button	Night/2gr	203		24
4 Number under button	Night/2gr	204		24
5 Number under button	Night/2gr	205		24
6 Number under button	Night/2gr	206		24
7 Number under button	Night/2gr	207		24
8 Number under button	Night/2gr	208		24
9 Number under button	Night/2gr	209		24
10 Number under button	Night/2gr	210		24
11 Number under button	Night/2gr	211		24
12 Number under button	Night/2gr	212		24
relay 1 works in mode	m=1 - 8	311		1
relay 2 works in mode	m=1 - 8	312		1



Password for relay 1 (1 pulse)	<b>Day+Night</b>	<b>3211</b>	6
password relay 1 (1pulse)	Day/Night	<b>3212</b>	6
password relay 1 (1pulse)	Day/Night	<b>3213</b>	6
password relay 1 (1pulse)	Day/Night	<b>3214</b>	6
password relay 1 (1pulse)	Day/Night	<b>3215</b>	6
password relay 1 (2pulses)	Day/Night	<b>321*</b>	6
password relay 2 (1 pulse)	Day/Night	<b>3221</b>	6
password relay 2 (1 pulse)	Day/Night	<b>3222</b>	6
password relay 2 (1 pulse)	Day/Night	<b>3223</b>	6
password relay 2 (1 pulse)	Day/Night	<b>3224</b>	6
password relay 2 (1 pulse)	Day/Night	<b>3225</b>	6
password relay 2 (2 pulses)	Day/Night	<b>322*</b>	6
Password relay 1 (1 pulse)	Day	<b>3311</b>	6
Password relay 1 (1 pulse)	Day	<b>3312</b>	6
Password relay 1 (1 pulse)	Day	<b>3313</b>	6
Password relay 1 (1 pulse)	Day	<b>3314</b>	6
Password relay 1 (1 pulse)	Day	<b>3315</b>	6
Password relay 1 (2 pulses)	Day	<b>331*</b>	6
password relay 2 (1 pulse)	Day	<b>3321</b>	6
password relay 2 (1 pulse)	Day	<b>3322</b>	6
password relay 2 (1 pulse)	Day	<b>3323</b>	6
password relay 2 (1 pulse)	Day	<b>3324</b>	6
password relay 2 (1 pulse)	Day	<b>3325</b>	6
password relay 2 (2 pulses)	Day	<b>332*</b>	6
Password relay 1 (1 pulse)	Night	<b>3211</b>	6
Password relay 1 (1 pulse)	Night	<b>3212</b>	6
Password relay 1 (1 pulse)	Night	<b>3213</b>	6
Password relay 1 (1 pulse)	Night	<b>3214</b>	6
Password relay 1 (1 pulse)	Night	<b>3215</b>	6
Password relay 1 (2 pulses)	Night	<b>321*</b>	6
password relay 2 (1 pulse)	Night	<b>3221</b>	6
password relay 2 (1 pulse)	Night	<b>3222</b>	6
password relay 2 (1 pulse)	Night	<b>3223</b>	6
password relay 2 (1 pulse)	Night	<b>3224</b>	6
password relay 2 (1 pulse)	Night	<b>3225</b>	6

password relay 2 (2 pulses)	Night	<b>322*</b>		6
Button selection for relay 1	m=6	<b>311*</b>		2
Button selection for relay 1	m=6	<b>312*</b>		2
Relay 1 activation by phone	1 pulse	<b>351</b>		2
Relay 2 activation by phone	1 pulse	<b>352</b>		2
Relay 1 activation by phone	2 pulses	<b>361</b>		2
Relay 2 activation by phone	2 pulses	<b>362</b>		2
Time of closing for relay 1	[sec]	<b>371</b>		2
Time of closing for relay 2	[sec]	<b>372</b>		2
Incoming call relay1 control	1 / 0	<b>381</b>		1
Incoming call relay2 control	1 / 0	<b>382</b>		1
Delay between closing relay 1 and 2	[sec]	<b>39</b>		2
Time between pulses rel 1	[sec]	<b>301</b>		2
Time between pulses rel 2	[sec]	<b>302</b>		2
Leaving button relay 1	0/1/2	<b>3*1</b>		2
Leaving button relay 2	0/1/2	<b>3*2</b>		2
Dial type tone / pulse	0 / 1	<b>41</b>		1
Call prolongation character	* / #	<b>42</b>		1
A-Bell hanging up by phone	1.	<b>431</b>		2
A-Bell hanging up by phone	2.	<b>432</b>		2
Service password		<b>44</b>		4
Code to switch into <b>DAY</b>		<b>45</b>		2
Code to switch into <b>NIGHT</b>		<b>46</b>		2
Doorphone dial mode	1 / 0	<b>47</b>		1
Hang up by same button p.	0 / 1	<b>4*</b>		1
Number of rings for pick up		<b>51</b>		1
Maximal call duration	[min]	<b>52</b>		1
Time between button press	[sec]	<b>53</b>		1
Hang up time - REDIAL	[sec]	<b>54</b>		1
Time before dial start	[sec]	<b>55</b>		1
Numb of rings bef. Hang up		<b>56</b>		2
Tone detector frequency	table	<b>500</b>	ms	1
Number of busy tones		<b>501</b>		1
Time duration of permanent tone		<b>502</b>	sec	2

Time duration of tone dial	nn x 10	<b>503</b>	ms	2
Space betweeni DTMF tones	nn x 10	<b>504</b>	ms	2
Flash duration	n x 100	<b>505</b>	ms	1
pause/ space between numbers	n x100+400	<b>506</b>	ms	1
DTMF transmission level	04-16	<b>507</b>	-dBm	2
preemphasis DTMF	0 / 1	<b>508</b>		1
Listening in DTMF - level	1-4	<b>509</b>		1
Acoustic signalling	0 / 1	<b>61</b>		1
Acoustic signalling Off hook /on hook	0 / 1	<b>62</b>		1
Acoustic signalling beeps	0 / 1	<b>63</b>		1
External power supply 12V	0 / 1	<b>64</b>		1
Acoustic signalling of relay activation	0 / 1	<b>65</b>		1
Depression of DTMF reception from microphone	0 /1	<b>66</b>		1
BabyCall	0 / 1	<b>67</b>		1
Number of buttons on panel	Up model	<b>6#</b>		1
Delayed start (Siemens)		<b>6*</b>		1
Reception loudness (TRH)	01-16	<b>71</b>		2
Transmission loudness (MIC)	01-16	<b>72</b>		2
Speaker loudness (SPK)	01-16	<b>73</b>		2
Soft pass of switching	0 / 1	<b>74</b>		1
Depression of background sound	0 / 1	<b>75</b>		1
Level of microphone start	1 - 4	<b>76</b>		1
Fast switching voice automatic	1 - 4	<b>77</b>		1
VA charakteristic	0 / 1	<b>78</b>		1
Compensation of wires losses	0 / 1 / 2	<b>79</b>		1
Signalling transmission level	04 - 16	<b>70</b>	-dBm	2
on/off.automatic switching	0 / 1 / #	<b>09</b>		0
Time setting	hhnn	<b>081</b>		4
Date setting+weekday <b>w</b>	ddmmyyw	<b>082</b>		7
Sunday	hhnkkj	<b>00</b>		8

Monday	hhnnkkjj	<b>01</b>		8
Tuesday	hhnnkkjj	<b>02</b>		8
Wednesday	hhnnkkjj	<b>03</b>		8
Thursday	hhnnkkjj	<b>04</b>		8
Friday	hhnnkkjj	<b>05</b>		8
Saturday	hhnnkkjj	<b>06</b>		8

**Warranty conditions:**

The product was shop-checked. The producer guarantees that this product will keep the features described in the operating instructions in the course of warranty provided the user handles the product as described in the manual. The warranty is extended by the period of possible warranty repair.

When claiming within the warranty period, kindly contact your dealer who sold you the product. The producer only makes warranty repairs. Please attach the description of the claim reason, the proof of purchase and your exact shipping/delivery address.

**The warranty does not include:**

- mechanical, thermal, chemical and other damages caused by user's activities
- defects caused by natural disasters
- defects caused by repair or changes carried out by the user or other unauthorized person
- willful damage of the product
- incorrect use of the product caused by other use than specified in the operating manual (e.g. wrong installation, wrong programming)
- damages caused during the product transport to the customer and during the transport from the supplier

Producer:
Dealer:
Date of purchase: