

The IP VarioBell quick setup guide

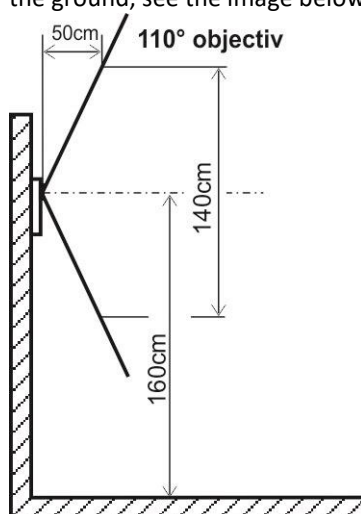

1. Assemble your IP VarioBell doorphone according to [the IP VarioBell assembly guide](https://www.alphatechtechnologies.cz/en/products/ip-intercoms/ip-variobell-doorphone), which you can download at <https://www.alphatechtechnologies.cz/en/products/ip-intercoms/ip-variobell-doorphone>
2. In case you need to setup DIP switches on the expansion call button modules, refer to the manual which you can download at <https://www.alphatechtechnologies.cz/en/products/ip-intercoms/ip-variobell-doorphone>
3. Install the IP VarioBell doorphone at the proper height, we recommend approx. 160cm above the ground, see the image below.



4. Door opening via an electrical lock. If you power the IP VarioBell doorphone just with the PoE switch (IEEE 802.af compliant), you can use a low consumption electrical lock only, suitable for PoE use with max. consumption of 220mA. In other case an external 12VDC/1A or 12VAC/1A power supply adapter is required. Prepare all your wiring, see some connection examples below.

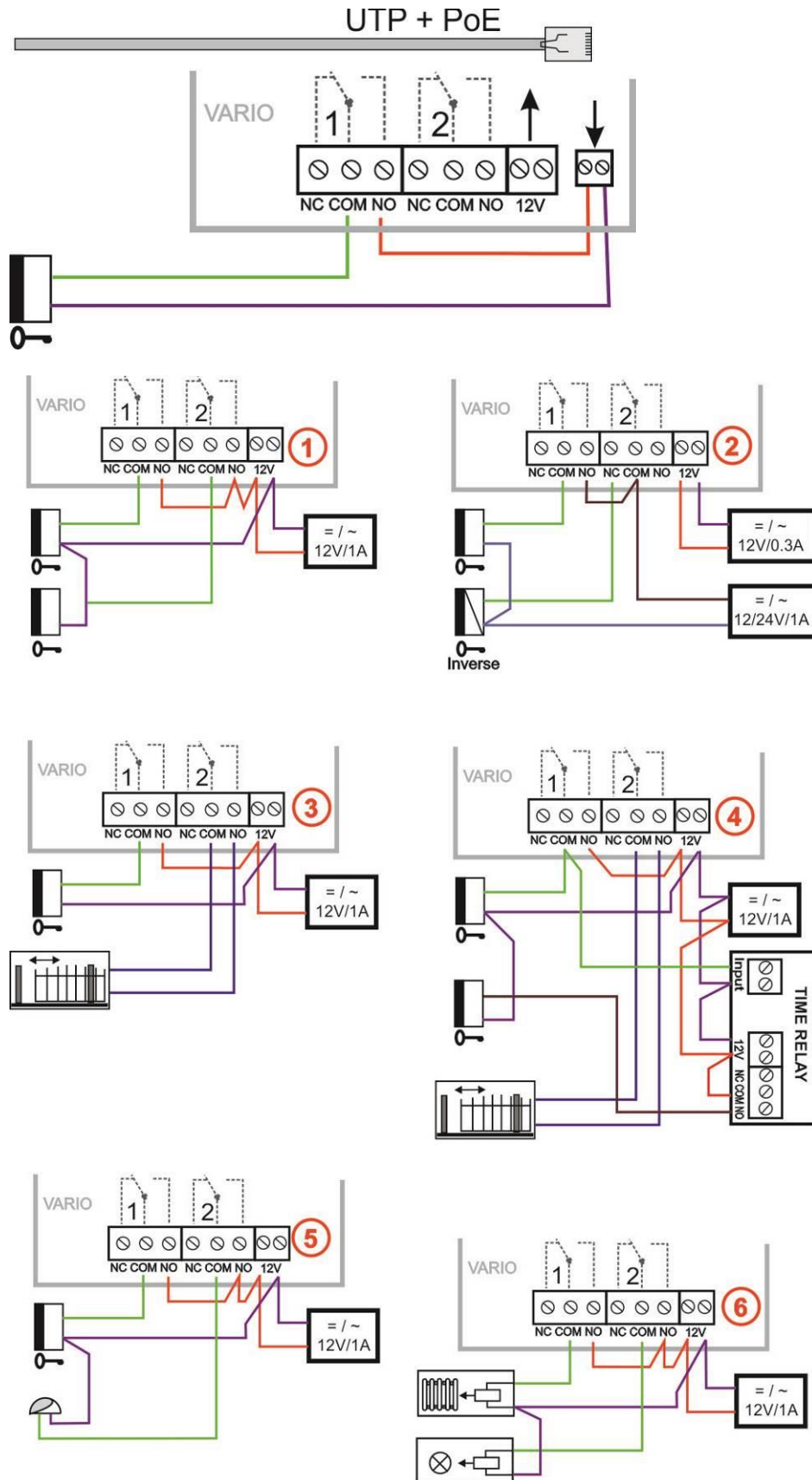

- Connect the UTP LAN cable with RJ45 port to the ETH port on the main board of the main module. See point 6 at the image below. Recommended PoE switch: TP-Link TL-SF1008P (IEEE)



802.af compliant) or you can use an optional 12VAC/1A or 12VDC/1A power supply in case it's needed at the installation site. See point 11 at the image below.

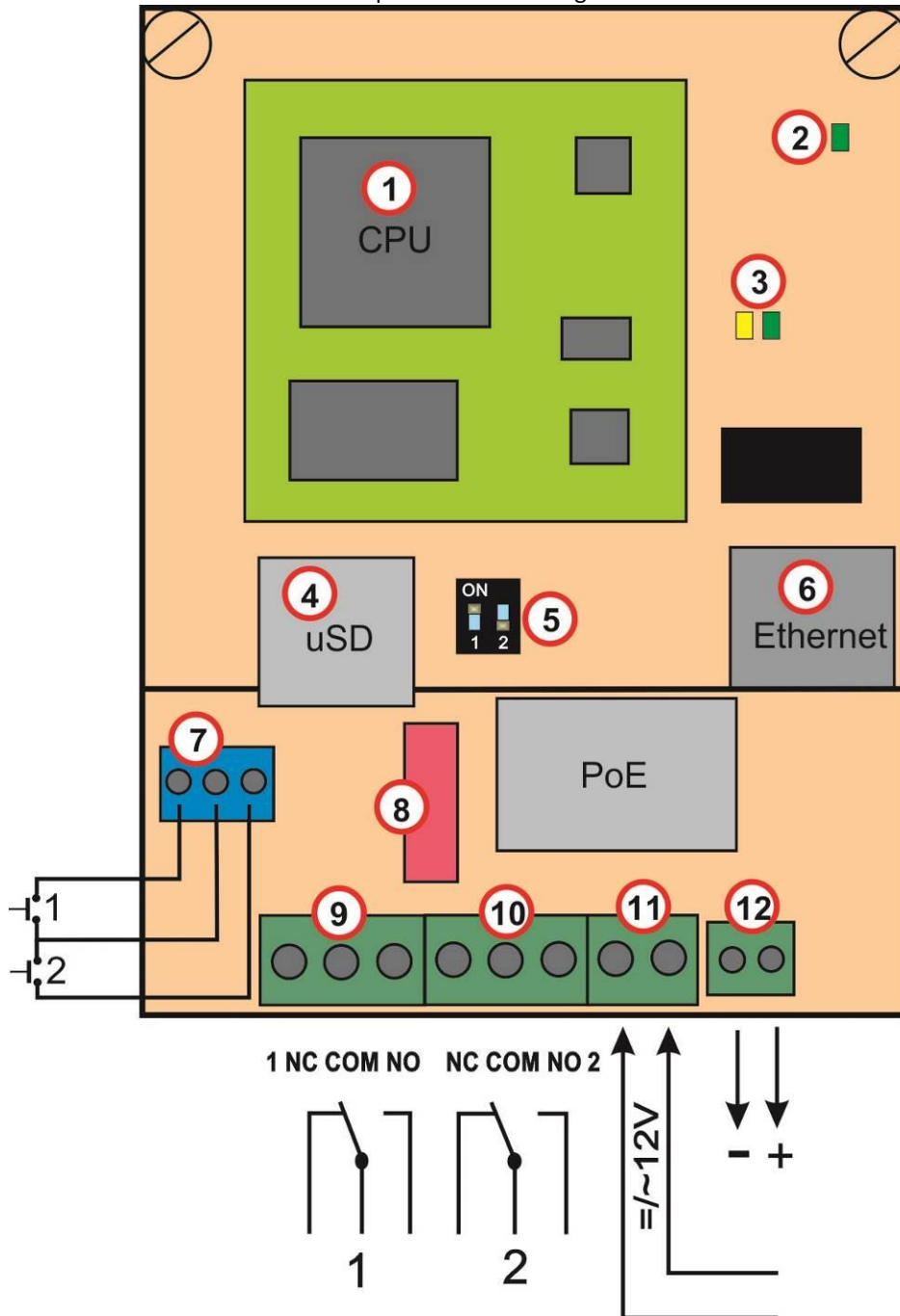

6. Login to the IP VarioBell doorphone. Setup your network access to 192.168.1.xxx on your PC. Once your PC is setup within the LAN network segment 192.168.1.xxx, enter 192.168.1.250 to your web browser. This IP address is the factory default, static IP address of the IP VarioBell doorphone. The window below will pop-up. Enter the user name admin and the default password 1234.

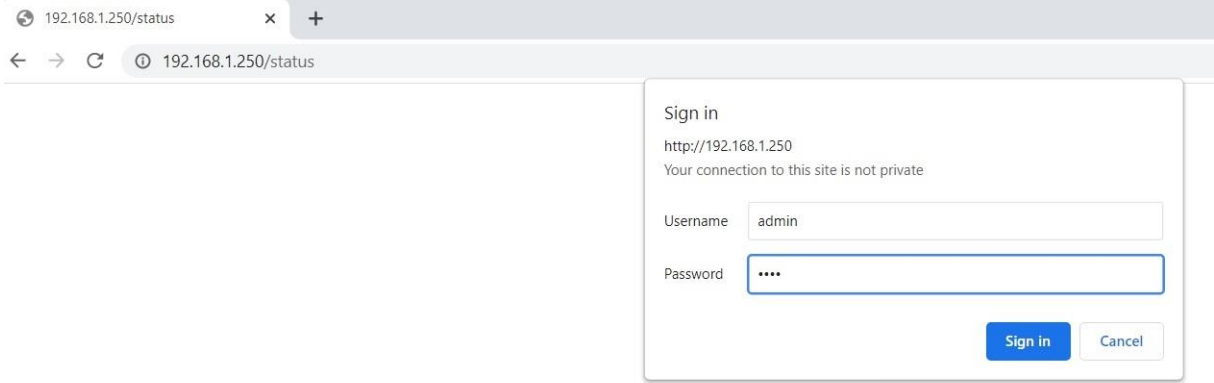

- Go to the section Extended settings – DoorPhone. See the image below. In case you have a factory pre-defined 1 call button on the main/basic module and you can see there is number 1 filled out in the window “Number of buttons on basic module”, keep it, do not change it. The factory pre-defined 1st call button on the main/basic module is always on the right side of the physical main/basic IP VarioBell module. In other case, if there is number 2 filled out as you can see it at the image below, then the 1st call button is located on the left side and the 2nd call button is located on the right side. If there are any expansion call buttons connected, define the number of expansion call buttons. If there is a keypad connected, select it (tick-in) and click on Save button to save your new settings.

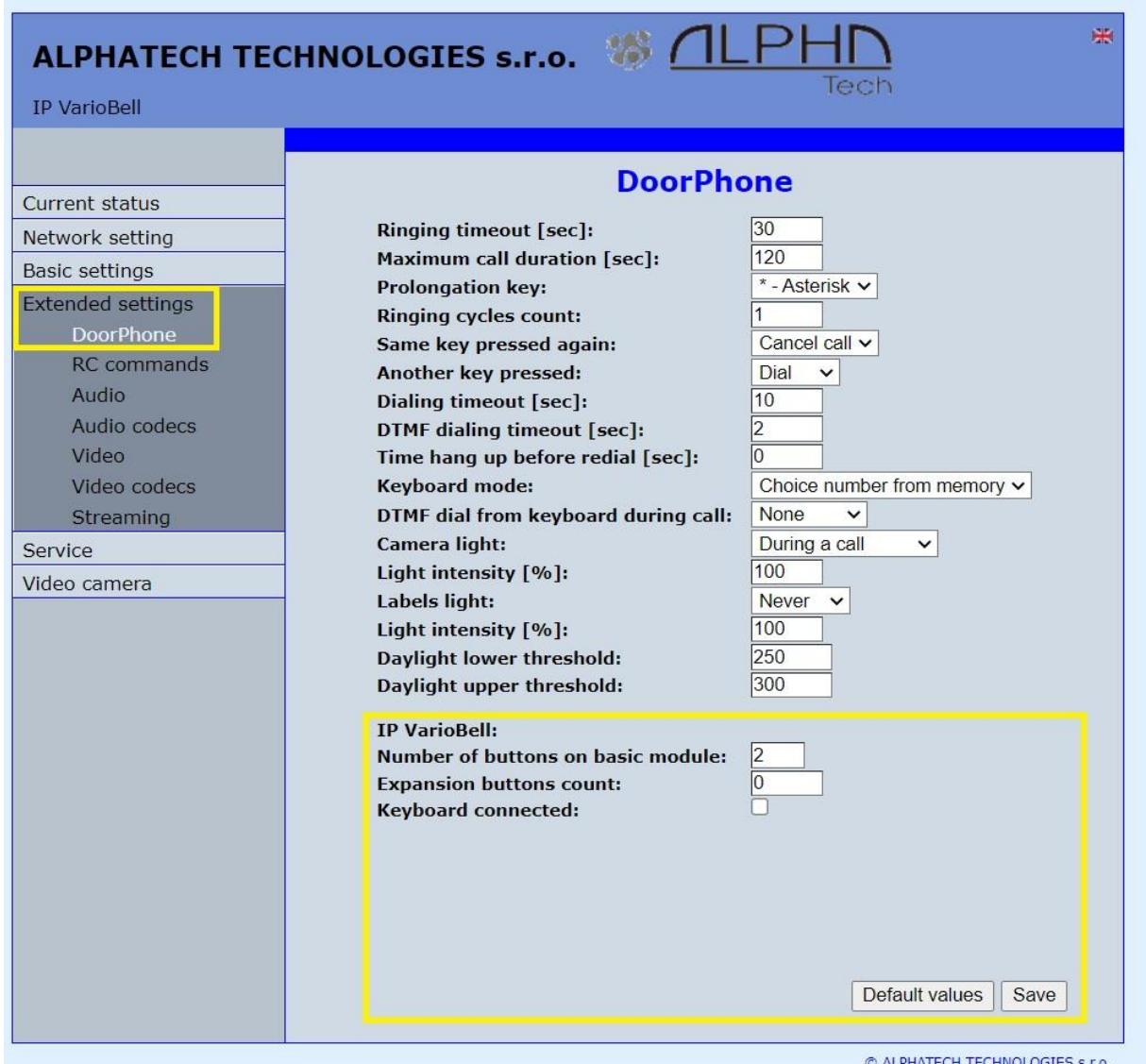

8. Setup with just one or two call buttons on the main/basic module. Go to Basic settings – Phonebook. Enable the individual call buttons by ticking-in the “Enable this page”. Click on Save to save your settings. In case you wish to use just one call button on the right side of the physical main/basic module and you can see there are two call buttons in the PhoneBook menu (number 1 and number 2 as you see below), then do not use Number 1 call button, skip it and use just Number 2 call button as your 1st call button. Do not use the Number 1 in the menu, avoid it. If there was a factory pre-defined just one call button on the main/basic module, you can use Number 1 in the PhoneBook menu as your 1st call button.

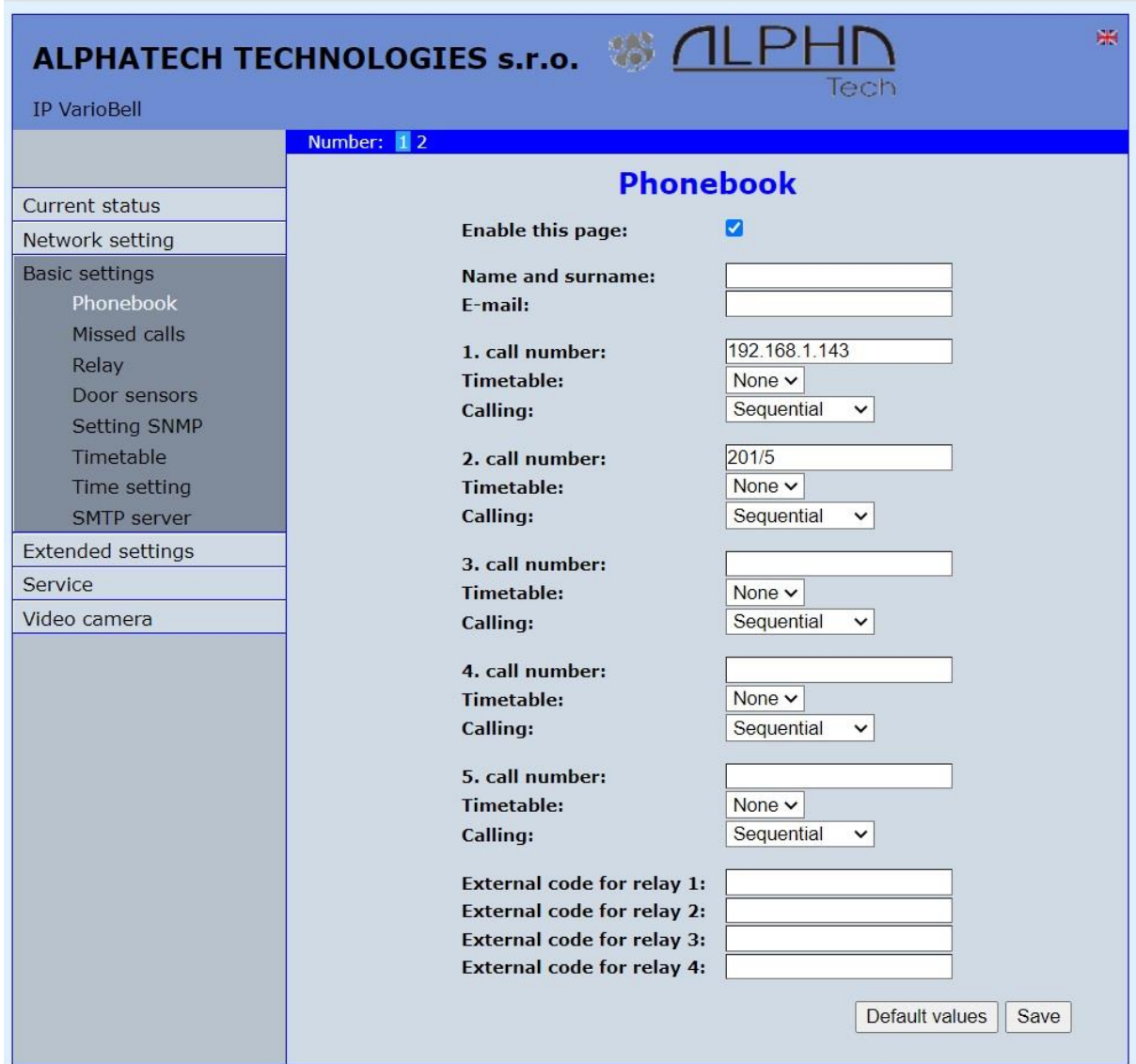

ALPHATECH TECHNOLOGIES s.r.o. 

IP VarioBell

Number: 1 2

Phonebook

Enable this page:

Name and surname:

E-mail:

1. call number:

Timetable:

Calling:

2. call number:

Timetable:

Calling:

3. call number:

Timetable:

Calling:

4. call number:

Timetable:

Calling:

5. call number:

Timetable:

Calling:

External code for relay 1:

External code for relay 2:

External code for relay 3:

External code for relay 4:

9. Setup with more than 2 call buttons or with keypad. Go to Basic settings – Phonebook. Enable the individual call buttons by ticking-in the “Enable this page”. Click on Save to save your settings. The main/basic module setup: If there was a factory pre-defined 1 call button on the main/basic module (see Extended settings – DoorPhone), then the Number 1 in the PhoneBook is your first call button on the physical main/basic module. In case you wish to use just one call button physically positioned on the right side of the main/basic module and you can see there is number 2 filled out in the window “Number of buttons on basic module” in the Extended settings menu, then do not use Number 1 position in the PhoneBook, skip it and use just the Number 2 position in the PhoneBook as your 1st call button. In this case do not use the Number 1 in the menu, disabled it in the menu, click on Save button and avoid using it. See the image below as an example of the disabled position Number 1 in the PhoneBook menu. Just remember



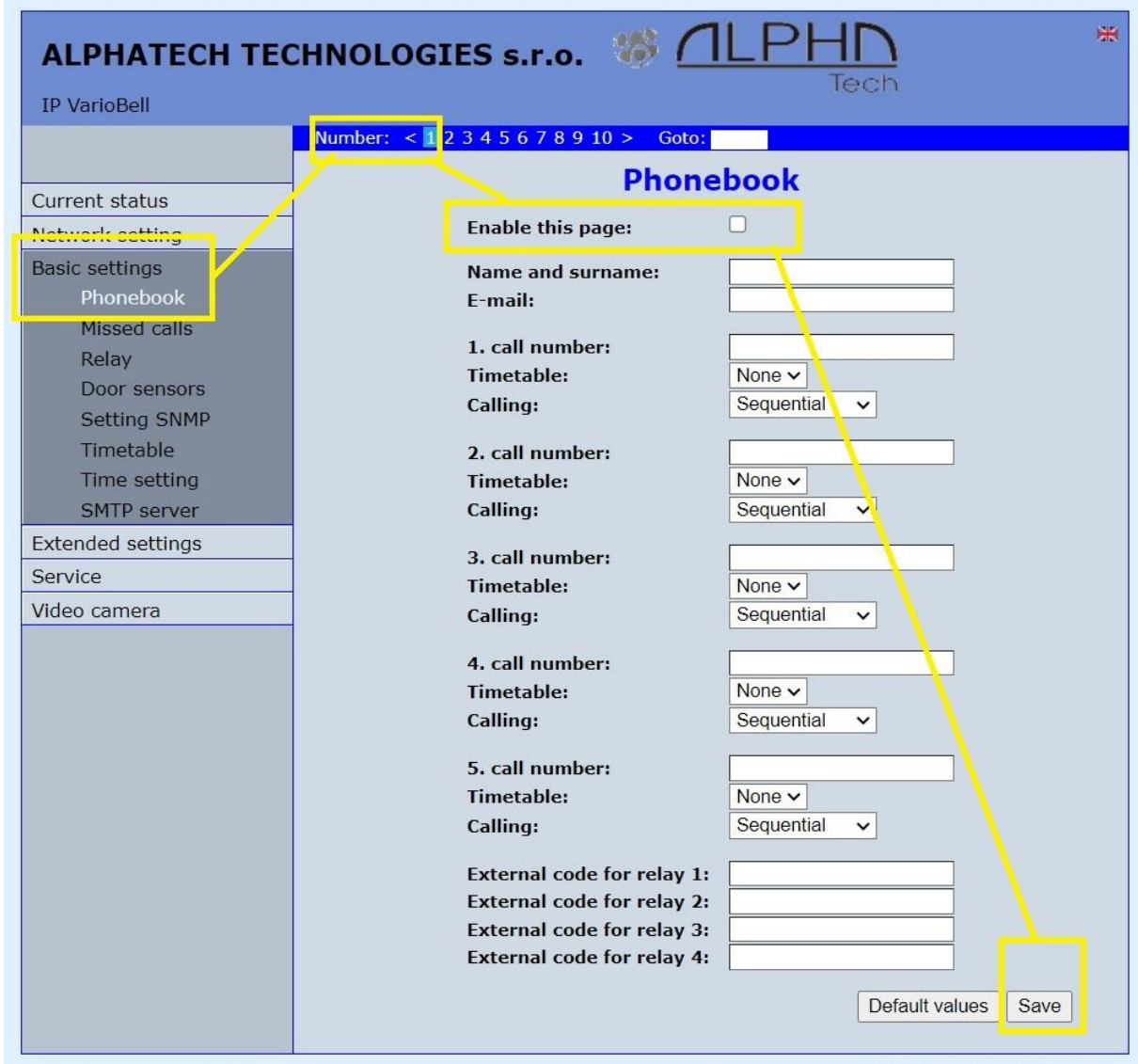

that the position Number 1 is empty and all your call buttons or keypad positions start from the Number 2 position in the PhoneBook.



- Calling an IP address or a sip extension. Fill in IP address within the network segment of the IP VarioBell doorphone to call directly the IP address of the SIP device. Fill in the extension number of the SIP device and refer to the correct SIP account (your own SIP server, IP PBX or external SIP cloud service), to which you have registered to IP VarioBell doorphone. In the example below you can see A987654/5. The number A987654 is the extension number of the called party, /5 refers to the fifth external SIP account in the Network setting – SIP account menu in the setup menu of the IP VarioBell doorphone. In case you wish to use an internal SIP registrar server of the IP VarioBell doorphone, just fill out the extension number, e.g., 200 as you can see in the image below, without any “forward slash” reference. Then you can call any SIP device registered directly to the IP address of the IP VarioBell doorphone. In this case you do not need to use any external SIP server or IP PBX.

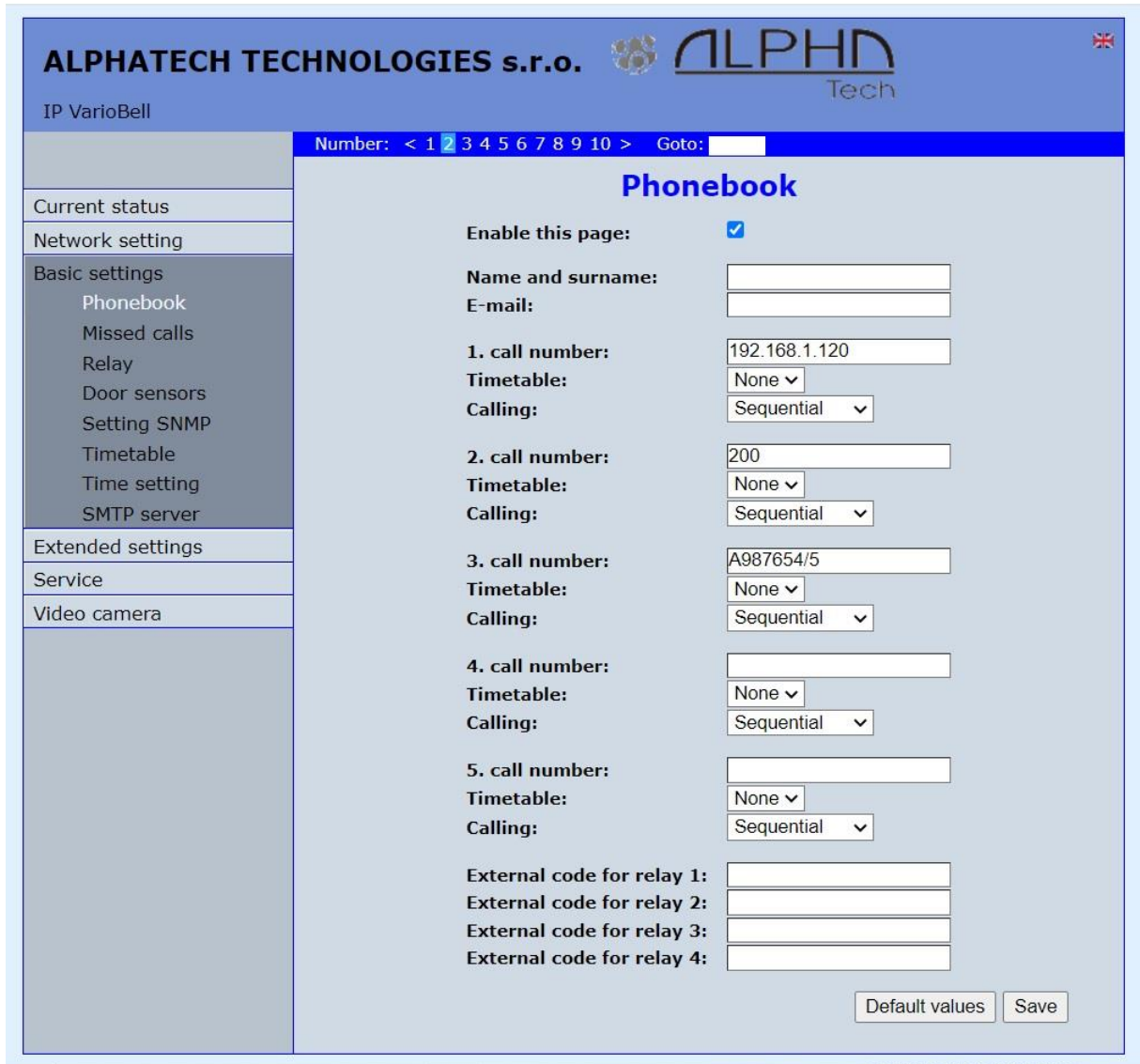



ALPHATECH TECHNOLOGIES s.r.o. 

IP VarioBell

Number: < 1 2 3 4 5 6 7 8 9 10 > Goto:

Phonebook

Enable this page:

Name and surname:

E-mail:

1. call number:

Timetable:

Calling:

2. call number:

Timetable:

Calling:

3. call number:

Timetable:

Calling:

4. call number:

Timetable:

Calling:

5. call number:

Timetable:

Calling:

External code for relay 1:

External code for relay 2:

External code for relay 3:

External code for relay 4:

11. If you use the internal SIP registrar server of the IP VarioBell doorphone for calling to your SIP devices, then make sure not to change any default settings in the SIP parameters, see the yellow marked section in the image below. Keep the default, i.e., the feature "Run internal registration server" must be enabled and Account must be always at the default value 250, never change it. Or click on Default values button and then click on Save button.



ALPHATECH TECHNOLOGIES s.r.o.  **ALPHATECH**
Tech

IP VarioBell

SIP parameters

Current status	Display name: IP VarioBell
Network setting	Provisional code: 180 Ringing
Network	Enable Symmetric RTP: <input type="checkbox"/>
SIP account	DSCP (QoS) value: 0
SIP parameters	Reject all incoming calls: <input type="checkbox"/>
Web server	Run internal registration server: <input checked="" type="checkbox"/>
Basic settings	Account: 250
Extended settings	SIP Transport: TCP & UDP
Service	
Video camera	

Default values Save

© ALPHATECH TECHNOLOGIES s.r.o.

12. Registration to your external SIP server, IP PBX or a SIP cloud service. Go to Network setting – SIP account. Fill in your credentials and click on Save button. Make sure you have access to internet. Without internet access, you cannot register to any external SIP server or SIP cloud service which is located outside of your LAN network. Check your network time server access in Time settings. Without Actual time, the IP VarioBell doorphone has no valid access to internet. See an example below with a valid internet access.

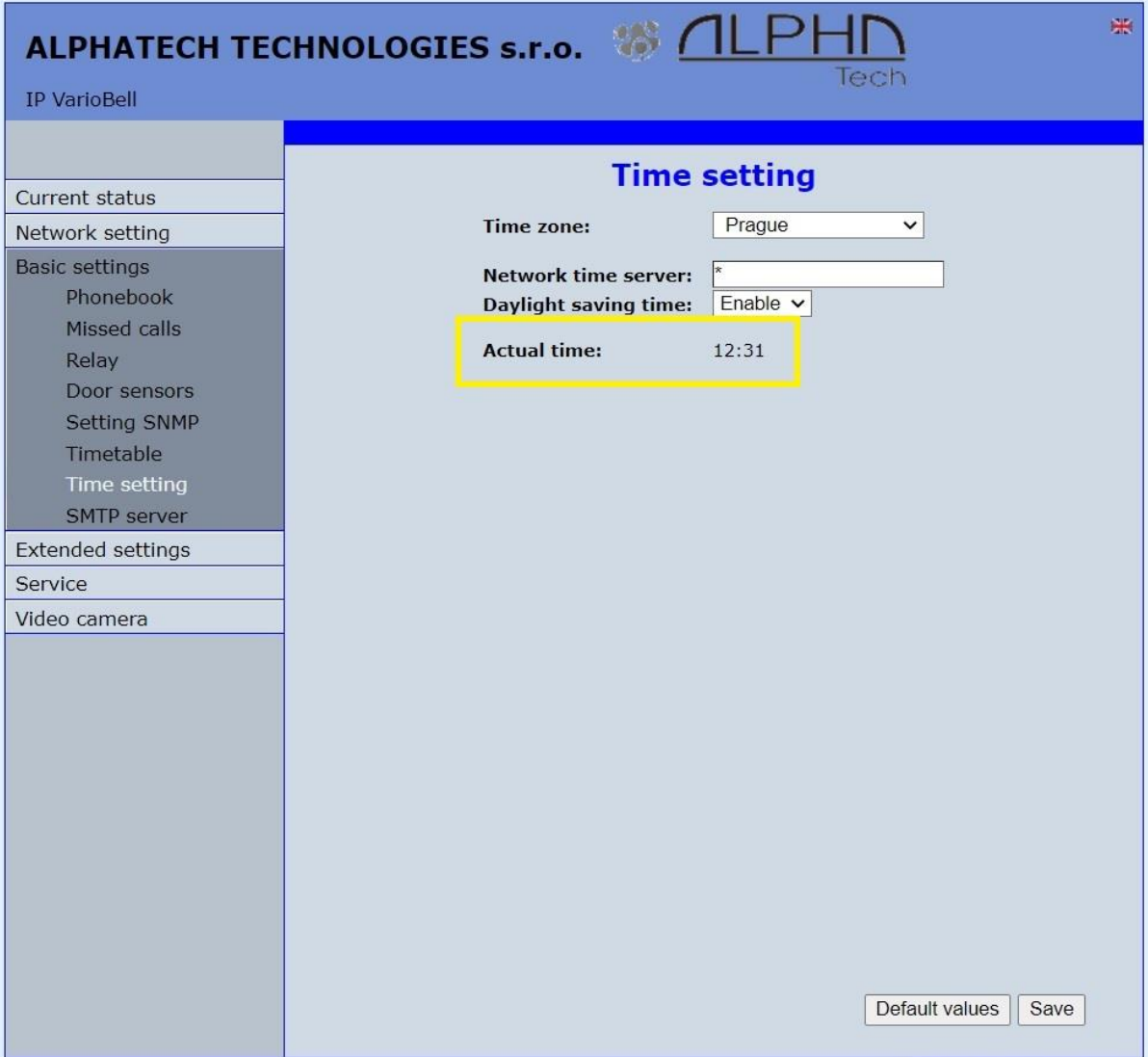

ALPHATECH TECHNOLOGIES s.r.o.  **ALPHATECH**
Tech

IP VarioBell

Time setting

Time zone: Prague ▾

Network time server: *

Daylight saving time: Enable ▾

Actual time: 12:31

Default values Save

© ALPHATECH TECHNOLOGIES s.r.o.

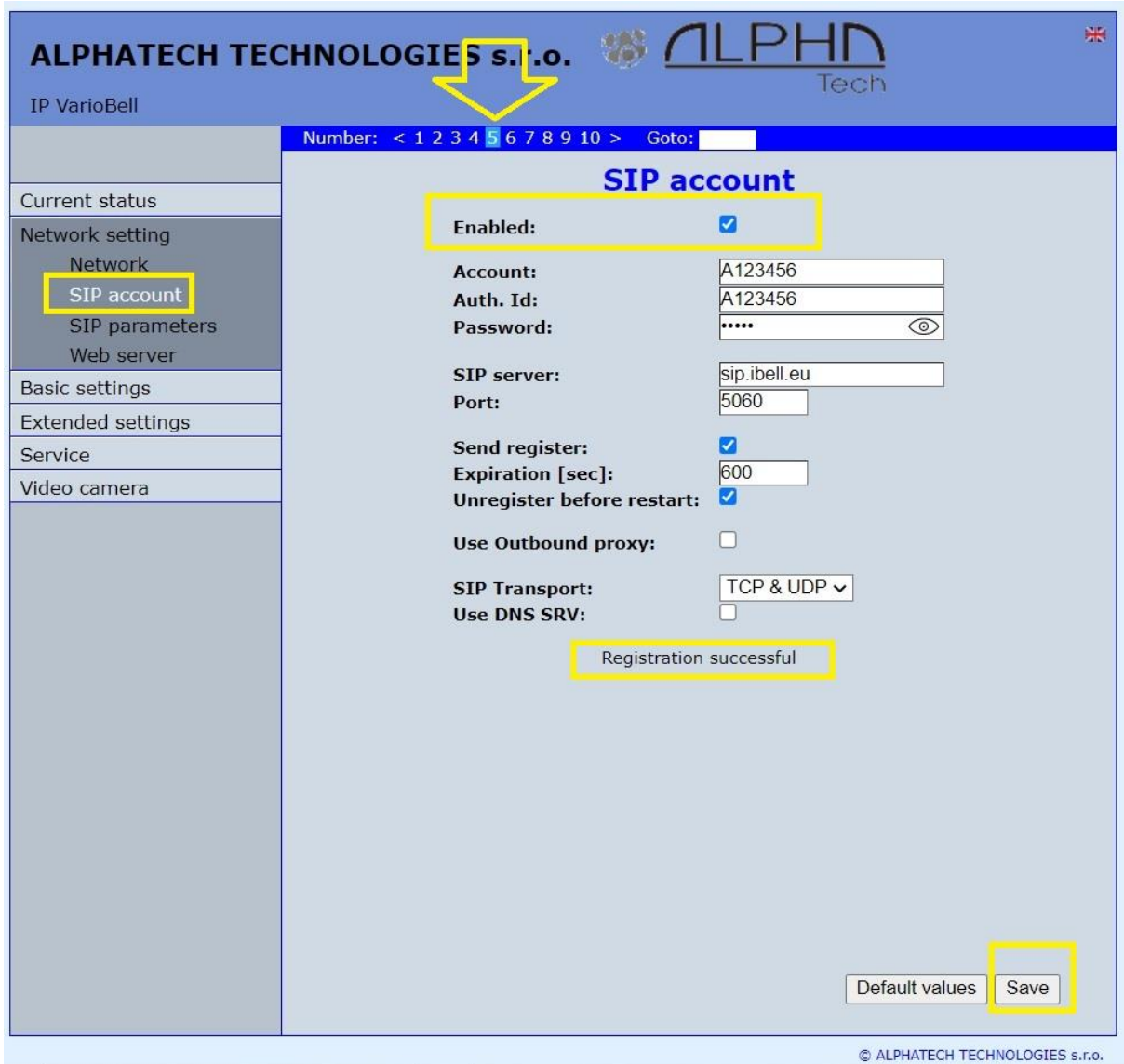

ALPHATECH TECHNOLOGIES s.r.o. IP VarioBell

Number: < 1 2 3 4 5 6 7 8 9 10 > Goto:

SIP account

Enabled:

Account:

Auth. Id:

Password:

SIP server:

Port:

Send register:

Expiration [sec]:

Unregister before restart:

Use Outbound proxy:

SIP Transport:

Use DNS SRV:

Registration successful

Default values **Save**

© ALPHATECH TECHNOLOGIES s.r.o.

13. MAC address and Actual status of internet connection of the doorphone. In the status menu, you can find the MAC address of the doorphone. To be sure your IP VarioBell doorphone has internet access, just check the actual time and date in the status menu. See an example below.



ALPHATECH TECHNOLOGIES s.r.o. IP VarioBell

Status

Display name	IP VarioBell
Firmware version	3.5.40
Buttons count	2
Keyboard connected	Yes
Camera connected	Yes
SD card size	
Card free space	
Customization	Alphatech Technologies
MAC address	00:56:34:00:13:96
Actual time	12:55 2021-06-18
Running time	1d 21h 0m



14. Setup your relays menu to open the door via DTMF command, see an example below.

ALPHATECH TECHNOLOGIES s.r.o.

IP VarioBell

Number: 1 2 3 4

Current status

Network setting

Basic settings

- Phonebook
- Missed calls
- Relay
- Door sensors
- Setting SNMP
- Timetable
- Time setting
- SMTP server

Extended settings

Service

Video camera

Relay

Enabled:

Timetable: None ▾

Relay mode: Monostable ▾

Delay time [sec]: 0

Run time [sec]: 5

Source: None ▾

Synchronize delay [sec]: 0

Active on call: Ignore ▾

Blocking by: None ▾

Acoustic tone: None ▾

Active by HTTP:

Security output code:

Direct ON button:

RC command at relay ON:

RC command at relay OFF:

	Code	Source		Timetable
1.	66	DTMF ▾	On ▾	None ▾
2.	 	Button ▾	Off ▾	None ▾
3.	 	Button ▾	Off ▾	None ▾
4.	 	Button ▾	Off ▾	None ▾
5.	 	Button ▾	Off ▾	None ▾
6.	 	Button ▾	Off ▾	None ▾
7.	 	Button ▾	Off ▾	None ▾
8.	 	Button ▾	Off ▾	None ▾
9.	 	Button ▾	Off ▾	None ▾
10.	 	Button ▾	Off ▾	None ▾

Default values
Save



15. HTTP streaming of the MJPG video: http://ip_address_of_your_doorphone/video.mjpg , for example <http://192.168.1.250/video.mjpg>
16. RTSP streaming of the RTSP video. In your VLC player please write URL:
`rtsp://ipaddress_of_the_doorphone/video.h264` , for example `rtsp://192.168.1.250/video.h264`
17. For an example setup with the [microSIP Windows app](#), please refer to this [microSIP setup guide](#).
18. Demo video with [Fritz!Box SIP server and Fritz!Fon5 dect video phones](#)
19. [Setup guide for the Linphone video softphone app](#)

