

Call center

BlackBox
AlphaLift
BlackSet



User guide

Table of contents

1	Introduction.....	4
2	Connection of Black Box	4
3	Description of BlackBoxu and accessories.....	5
3.1	<i>Description of Blackbox operation in automatic mode</i>	6
3.1.1	Incoming call.....	6
3.1.2	Outgoing call.....	6
4	Control commands and answers.....	7
4.1	<i>Basic commands.....</i>	7
4.1.1	AT - OKnn.....	7
4.1.2	ATA - OK.....	7
4.1.3	ATH - OK.....	7
4.1.4	AT@RGUP - OK.....	7
4.1.5	AT@BASIC - OK.....	7
4.1.6	AT@RESET.....	7
4.1.7	AT@NORM - OK.....	7
4.1.8	AT@AUTO - OK.....	7
4.1.9	AT@TYPEn - OK.....	7
4.1.10	AT@TYPGn - OK.....	7
4.1.11	AT@MODn - OK / xOK.....	7
4.1.12	AT@GLWn - OK.....	8
4.2	<i>Signalling commands.....</i>	8
4.2.1	AT@DITI - OK.....	8
4.2.2	AT@BUTI - OK.....	8
4.2.3	AT@BUTE - OK.....	8
4.2.4	AT@RGTE - OK.....	8
4.2.5	AT@MUTI - OK.....	8
4.2.6	AT@MUTE - OK.....	8
4.3	<i>Connection commands</i>	8
4.3.1	AT@CONI - OK.....	8
4.3.2	AT@CONN - OK.....	8
4.4	<i>Dial receiving commands.....</i>	8
4.4.1	AT@RECI - OK.....	8
4.4.2	AT@RECE - OK.....	8
4.4.3	AT@RECN - nn.....nOK.....	9
4.5	<i>Dial sending commands.....</i>	9
4.5.1	ATDInn...n - OK.....	9
4.5.2	ATDEnn...n - OK.....	9
4.5.3	ATDIM - OK.....	9
4.5.4	ATDEM - OK.....	9
4.5.5	AT@MInn...n - OK.....	9
4.5.6	AT@MEnn...n - OK.....	9
4.6	<i>CLIP sending commands.....</i>	9
4.6.1	AT@FSKI - OK.....	9
4.6.2	AT@FSKE - OK.....	9
4.6.3	AT@FSKI&Dmddhhnn&Ntt...t&Cnn...n - OK.....	10
4.6.4	AT@FSKE&Dmddhhnn&Ntt...t&Cnn...n - OK.....	10
4.6.5	AT@DTCI - OK.....	10
4.6.6	AT@DTCE - OK.....	10

4.6.7	AT@DTCI&Cnn...n - OK.....	10
4.6.8	AT@DTCE&Cnn...n - OK.....	10
4.7	Commands to control OGM message module.....	11
4.7.1	AT@OGMI - OK.....	11
4.7.2	AT@OGME - OK.....	11
4.7.3	AT@OGRTI - WAIT RTS - OK.....	11
4.7.4	AT@OGRTE - WAIT RTS - OK.....	11
4.7.5	AT@OGRII - WAIT RTS - OK.....	11
4.7.6	AT@OGRIE - WAIT RTS - OK.....	11
4.8	Setting parametres commands.....	11
4.8.1	AT@TIMEnn - OK.....	11
4.8.2	AT@P01n - OK.....	11
4.8.3	AT@P02n - OK.....	12
4.8.4	AT@P03n - OK.....	12
4.8.5	AT@P04n - OK.....	12
4.8.6	AT@P05n - OK.....	12
4.8.7	AT@P06n - OK.....	12
4.8.8	AT@P07n - OK.....	12
4.8.9	AT@P08n - OK.....	12
4.8.10	AT@P09n - OK.....	12
4.8.11	AT@P10n - OK.....	13
4.8.12	AT@P11n - OK.....	13
4.8.13	AT@P12nn - OK.....	13
4.8.14	AT@P13nn - OK.....	13
4.8.15	AT@P14n - OK.....	13
4.8.16	AT@P15nn - OK.....	13
4.8.17	AT@P16nn...n - OK.....	13
4.8.18	AT@DEFAULT - OK.....	13
4.9	Answers.....	13
4.9.1	POL , RING.....	13
4.9.2	FSKC.....	14
4.9.3	DTMC.....	14
4.9.4	CLIPnn...n.....	14
4.9.5	DATEmddhhnn.....	14
4.9.6	NAMEtt...t.....	14
4.9.7	WAIT RST.....	14
4.9.8	END.....	14
4.9.9	FULL.....	14
4.9.10	ERR.....	14
4.9.11	NOLINE.....	14
4.9.12	VER:x.x , RESET.....	14
4.9.13	PICK , HANG.....	15
5	Technical parametres.....	16
6	Program BlackSet.....	17
6.1	Select device.....	17
6.2	Record message to OGM module.....	17
6.3	Manual transmite and receive commands.....	18
6.4	Easy setting.....	18
6.5	Firmware update.....	19
7	Program AlphaLift – connect BlackBox in network.....	20

1 Introduction

Black Box is device designed for wide spectrum of use particularly for analogue line operation control. It includes one external line (behaviour as normal phone) and one internal line (on its is possible connect phone). The control is possible from your PC through USB port where you can connect a couple of Black Boxes. This device has except full operation control also automatic mode which allows you automatic data collection from Lift communicators (GSM Lift Watch and Link Lift Watch).

2 Connection of Black Box

The front cover includes all connection as same as signalling elements:

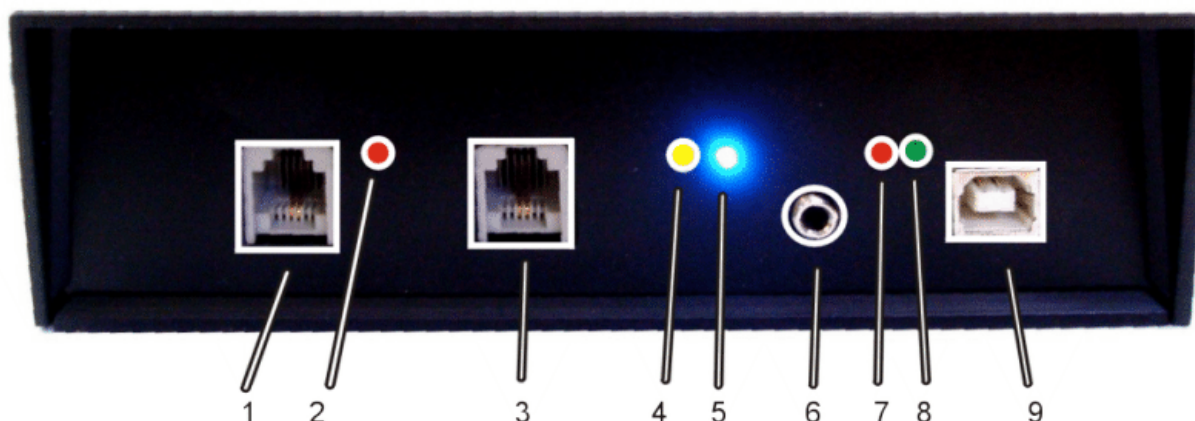

The description is made from left side:

1. RJ-11 connector for external line connection
2. RED LED – signalling of external line ON HOOK
3. RJ-11 connector for internal line connection (phone)
4. YELLOW LED – signalling of external line connection (during ON HOOK)
5. BLUE LED – operation status
6. Jack 3.5mm connector for connection signal source for loading of message
7. RED LED - signalling of Tx on USB port
8. GREEN LED – signalling Rx on USB port
9. USB port for PC connection
10. From back panel is power supply interface

BLUE LED – signalling of operation:

light permanently

- **standard** operation
- message module is **not included**
- stand by mode

flashing slowly (light longly, not light shortly)

- **automatic** operation
- message module is **not included**
- stand by mode

flashing quickly (light longly, not light shortly)

- **standard** operation
- message module is **included**
- stand by mode

flashing slowly 2x (light longly, not light shortly)

- **automatic** operation
- message modul is **included**
- stand by mode

flashing quickly (symetrically)

- firmware loading

flashing unregularly

- CLIP FSK or DTMF receiving

3 Description of BlackBox and accessories

Black Box is unit inserted into analogue line enables:

- ending of external line (active), as external line card in the PBX
- ending of internal line (pasive), as extension in the PBX
- detects and generates ringing signal
- generates acoustic signalling
- detects DTMF CLIP as same as FSK CLIP in format Bell even BT
- generates DTMF CLIP as same as FSK CLIP in format Bell
- detects and generates DTMF dial
- pulse dialling is not supported
- support internal connection (by cross point as in PBX) connection external and internal line with detection of DTMF dial
- support external (real connection by relay contacts) connection external and internal line with detection of line ON HOOK
- play – record message particularly for internal and external line (max.2x10sec)
- all operation parametres are adjustable and saved in EEPROM memory.
- 2 operation modes – NORM which is full control via USB port, - AUTO which is automatic operation with sending of events to PC via USB port.

The commands are to control Black Box. The answers are statuses which are created in Black Box. For communication you have to use PC with USB port . In PC must be installed driver for Black Box and programm which enables to control.

In the base are 2 programms.

AlphaLift – programm to control Black Box in automatic mode. It is in fact one purpose application which have to assure the type of call, where from is coming and seriál number of the calling unit. This application is designed for reporting of calls coming from lift cabins. It can be emergency call (calling of person from failed lift), service call (this call is done automatically every 3th day by unit installed in the lift to check full functionality) and alarm (error) call (it is sending information about errors (failures) of the lift, for example: electricity failure. The last two types of calls at GSM lift Watch can be solved by connection of GSM GATE (modem) to PC (via RS 232 interface) with installed AlphaLift programm or via RS 232 / USB convertor to USB port. The servise as same as alarm calls which dont need operator (voice) assistance is managed by SMS messages.

BlackSet is designed for synchronised recording of messages to message module from WAV files. Further for new firmware loading (flash downloading) and last function is monitor where you can tape commands to appropriate Black Box and see answers as well.

OGM modul is detectintion automaticaly in BlackBox.

3.1 Description of Blackbox operation in automatic mode

3.1.1 Incoming call

Incoming call is call coming from external line. Someone is calling to operator – Call centre.

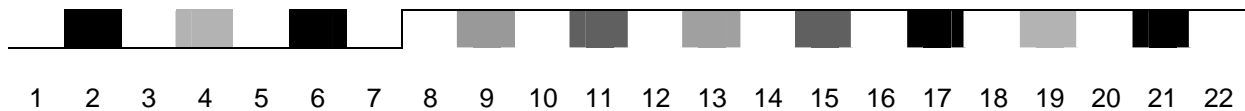

Picture 1. Incoming call

1. stand by
2. incoming ring for example from LLW – call from lift cabin
3. wait for CLIP receipt
4. detection of DTMF / FSK CLIP
5. wait for appropriate number (min. one more) ring
6. last ring receipt
7. wait for pick up (ON HOOK)
8. picked up and wait for sending confirmation acknowledgement
9. send confirmation acknowledgement (for example *66)
10. wait for answer
11. answer – serial number
12. wait for sending confirmation acknowledgement
13. sending confirmation acknowledgement (for example. *66)
14. wait for answer
15. answer – serial number. Where 2 serial numbers are the same (verification) then detection is ended
16. when serial numbers are not the same it is adjustable number of repetition
17. ring into internal line (to operator)
18. wait before CLIP sending
19. send received CLIP
20. wait for second ring
21. ringing. When nobody picked up or timeout is over the ringing is repeated
22. After picking up the call is transferred to operator. After hanging up it is going to stand by - 1.

During process 17-21 is play into external line (to communicator LLW or GSM LW) message recorded in OGM Message module. When OGM message module is not integrated the ringing tone is generated.

3.1.2 Outgoing call

The outgoing call is call outside to other external line. It is done from operator phone set. This call is not recommended because block emergency incoming call.

After picking up operator phone set is internal line connected to external line and wait for call ending – hang up. In this case is supported pulse dialling as same as Flash. The BlackBox is pasive in this case.

4 Control commands and answers

4.1 Basic commands

4.1.1 AT - OKnn

This command is inquiry only. It checks status of BlackBox. The status number is always 2 digit and it is mention in answer OKnn, nn is status number.

4.1.2 ATA - OK

Pick up external line – close the loop and end by impedance 600ohm

4.1.3 ATH - OK

Hang up external line – disconnect the loop

4.1.4 AT@RGUP - OK

Start ringing to internal line – repeatedly ringing 0,8sec ring / 2sec not ring

4.1.5 AT@BASIC - OK

Make stand by setting. Disconnect all and make basic(default) setting

4.1.6 AT@RESET

Make reset of Black Box – it is same as switch ON power supply

4.1.7 AT@NORM - OK

Příkaz nastaví Blackbox do normálního režimu, reaguje pouze na příkazy

4.1.8 AT@AUTO - OK

Set (switch) BlackBox to automatic mode

4.1.9 AT@TYPE_n - OK

Set type of BlackBox behaviour in automatic mode:

n = 0 – available to receive service and alarm calls, it means not ring to operator

n = 1 – available to receive emergency calls, it means ring to operator (you must connect phone to internal line)

4.1.10 AT@TYPG_n - OK

Supress ID algorithym of BlackBox behaviour in automatic mode:

n = 0 – ask for ID is supressed

n = 1 – normal function – asked for ID

4.1.11 AT@MOD_n - OK / xOK

Switch to day/night status in automatic mode. In night mode is call after receive CLIP rejection.

n = 0 – Night mode

n = 1 – Day mode

n = ? – Inquiry on state – 1OK=DAY, 0OK=NIGHT

4.1.12 AT@GLWn - OK

Switch to NLLW / GLW communicator in AUTO and NIGHT mode for receive night call.

n = 0 – Receive in night mode GLW call (long ringing without pickup)

n = 1 – Receive in night mode NLLW call (pickup and hangup)

4.2 Signalling commands

4.2.1 AT@DITI - OK

Start generates dial tone to internal line

4.2.2 AT@BUTI - OK

Start generates busy tone to internal line

4.2.3 AT@BUTE - OK

Start generates busy tone to external line

4.2.4 AT@RGTE - OK

Start generates ringing tone to external line

4.2.5 AT@MUTI - OK

Make cancel of all signalling actions – silent to internal line

4.2.6 AT@MUTE - OK

Make cancel of all signalling actions – silent to external line

4.3 Connection commands

4.3.1 AT@CONI - OK

Make connection internal and external line through cross point inside Black Box. At the same time receive DTMF dial. Attenuation of connection is cca 4dB and connection is galvanically isolated.

4.3.2 AT@CONN - OK

Make connection internal and external line through relay contacts inside Black Box. At the same time check current loop and due this detects ending of call (send „END“). Attenuation of connection is 0dB and connection is galvanically isolated.

4.4 Dial receiving commands

4.4.1 AT@RECI - OK

Make switching of receiver to internal line and put receiving buffer to zero.

4.4.2 AT@RECE - OK

Make switching of receiver to external line and put receiving buffer to zero.

4.4.3 AT@RECN - nn.....nOK

Send content of receiving buffer (not erase it). Received characters precluding OK.

1234567890*#ABCDOK – it is all 16 characters which can be evaluated

OK – buffer is empty – nothing received

Buffer size is 16 characters. When exceeded send „**FULL**“

4.5 Dial sending commands

4.5.1 ATDInn...n - OK

Make sending DTMF dial of number nn...n to internal line (max. 16 digits).

4.5.2 ATDEnn...n - OK

Make sending DTMF dial of number nn...n to external line (max. 16 digits).

4.5.3 ATDIM - OK

Make sending DTMF dial of number saved in EEPROM memory to internal line. (the number stays in memory even after switching off power supply)

4.5.4 ATDEM - OK

Make sending DTMF dial of number saved in EEPROM memory to external line. (the number stays in memory even after switching off power supply)

4.5.5 AT@MInn...n - OK

Make saving of number nn...n for internal line to EEPROM memory (the number stays in memory even after switching off power supply , max. 16 digits).

4.5.6 AT@MEnn...n - OK

Make saving of number nn...n for external line to EEPROM memory (the number stays in memory even after switching off power supply , max. 16 digits).

4.6 CLIP sending commands

4.6.1 AT@FSKI - OK

Make sending FSK CLIP to internal line – from buffer which has been filled either by CLIP received from external line or by command. After CLIP sending the buffer content stays. The buffer is sending (when is saved)- number (max. 24 digits), name (max. 20 characters) and date includes time (month,day,hours,minutes – 8 characters)

4.6.2 AT@FSKE - OK

Make sending FSK CLIP to external line – from buffer which has been filled either by CLIP received from external line or by command. After CLIP sending the buffer content stays. The buffer is sending (when is saved)- number (max. 24 digits), name (max. 20 characters) and date includes time (month,day,hours,minutes – 8 characters)

4.6.3 AT@FSKI&Dmmddhhnn&Ntt...t&Cnn...n - OK

Make buffer erasing, filling by new data and sending FSK CLIP to internal line. Saving is done as follow: after AT@FSKI follows & and big alphabetic determine what will be save. All characters saves to appropriate part of buffer and then follow either & or „enter“. In first case the saving to buffer is continue , in second case the saving is ended and all buffer content is sending out.

Alphabetics follow after &:

Cnn...n where nn...n are numbers of CLIP (max. 24 digits)

Dmmddhhnn where mm is month, dd is day, hh are hours and nn are minutes

Ntt...t where tt...t are name characters in CLIP (max. 20 characters)

Examples:

AT@FSKI&NHelo&C1234 - send CLIP number only **1234** and name **Helo**

AT@FSKI&D02131523&D11242156 – first command of date and time is rewrite by second and in CLIP is sending date and time **24.11. 21:56** only.

4.6.4 AT@FSKE&Dmmddhhnn&Ntt...t&Cnn...n - OK

Make buffer erasing, filling by new data and sending FSK CLIP to external line. Saving is done as follow: after AT@FSKI follows & and big alphabetic determine what will be save. All characters saves to appropriate part of buffer and then follow either & or „enter“. In first case the saving to buffer is continue , in second case the saving is ended and all buffer content is sending out.

Alphabetics follow after &:

Cnn...n where nn...n are numbers of CLIP (max. 24 digits)

Dmmddhhnn where mm is month, dd is day, hh are hours and nn are minutes

Ntt...t where tt...t are name characters in CLIP (max. 20 characters)

Examples:

AT@FSKI&NHelo&C1234 - send CLIP number only **1234** and name **Helo**

AT@FSKI&D02131523&D11242156 – first command of date and time is rewrite by second and in CLIP is sending date and time **24.11. 21:56** only.

4.6.5 AT@DTCI - OK

Make sending DTMF CLIP to internal line – from buffer which has been filled either by CLIP received from external line or by command. After buffer content sending it stays. Sending only number (max. 24 characters).

4.6.6 AT@DTCE - OK

Make sending DTMF CLIP to external line – from buffer which has been filled either by CLIP received from external line or by command. After buffer content sending it stays. Sending only number (max. 24 characters).

4.6.7 AT@DTCI&Cnn...n - OK

Make buffer erasing, filling by new data and sending DTMF CLIP to internal line. Saving is done as follow: after AT@DTCI follows & and big alphabetic C . All characters saves to appropriate part of buffer. Saving is ended and immediately all buffer content is sending out.

Cnn...n where nn...n are CLIP numbers (max. 24 digits)

4.6.8 AT@DTCE&Cnn...n - OK

Make buffer erasing, filling by new data and sending DTMF CLIP to external line. Saving is done as follow: after AT@DTCE follows & and big alphabetic C . All

characters saves to appropriate part of buffer. Saving is ended and immediately all buffer content is sending out.

Cnn...n where nn...n are CLIP numbers (max. 24 digits)

4.7 Commands to control OGM message module

The OGM message modul content 2x (10 seconds) memory space where you can download various messages. First is designed for announcing to internal line and second for announcing to external line.

4.7.1 AT@OGMI - OK

Play first message to internal line.

4.7.2 AT@OGME - OK

Play second message to external line.

The message recording is done either from phone connected to internal line , by connected external signal source (CD player, radio, etc....), or from PC. After appropriate command inserting the Black Box waiting for RTS signal change. During this time is permanently sending via USB port „WAIT RTS“. When you set signal RTS to „1“, then recording has been started. Stop recording is possible either by RTS signal change to „0“ or after filling of memory space – 10sec. When you will use PC for recording as same as BlackSet software the recording is done automatically.

4.7.3 AT@OGRTI - WAIT RTS - OK

Recording of message for internal line by phone.

4.7.4 AT@OGRTE - WAIT RTS - OK

Recording of message for external line by phone .

4.7.5 AT@OGRII - WAIT RTS - OK

Recording of message for internal line from external signal source – „Jack“ connector placed on front panel.

4.7.6 AT@OGRIE - WAIT RTS - OK

Recording of message for internal line from external signal source – „Jack“ connector placed on front panel.

4.8 Setting parametres commands

4.8.1 AT@TIME nn - OK

[nn = 01-99]

default nn=12

Setting time of ringing. It is max time for which Black Box ring to operator. When this time is over the Black Box stop ringing and hang up incoming call. It is going to stand by mode afterward to be able receive further calls.

Time is $nn \times 5\text{sec}$, $nn=05 - 25\text{sec}$, $nn=12 - 60\text{sec}.....$

4.8.2 AT@P01 n - OK

[n = 1-9]

default n=3

Setting of line ON HOOK . It means time from last ring when external line will be picked up . On picture 1 it this parametr marked 7.

Time is $n \times 0,3\text{sec}$, $n=3 - 1\text{sec}$, $n=9 - 3\text{sec}$

4.8.3 AT@P02n - OK

[n = 1-9]

default n=4

Setting of time without ring . It means - after how long time the ringing counter will be erased (cleared to 0).

Time is $n \times 2,5\text{sec}$, $n=3 - 1\text{sec}$, $n=9 - 3\text{sec}$

4.8.4 AT@P03n - OK

[n = 1-9]

default n=1

Setting of rings number before automatic pick up. It means after how many rings the external line will be picked up. First ring is mandatory due CLIP receipt and further rings are adjustable – $n=1-9$

Number is $n + 1$, $n=1 - 2$ rings, $n=9 - 10$ rings

4.8.5 AT@P04n - OK

[n = 1-9]

default n=2

Setting of time after picked up before sending acknowledgement confirmation in automatic mode. On picture 1 is this parametr marked 8.

Time is $n \times 0,3\text{sec}$, $n=3 - 1\text{sec}$, $n=9 - 3\text{sec}$

4.8.6 AT@P05n - OK

[n = 1-6]

default n=1

Setting of Flash duration in numbers dial. It means duration of line break.

Time is $n \times 0,1\text{sec}$, $n=1 - 100\text{ms}$, $n=6 - 600\text{ms}$

4.8.7 AT@P06n - OK

[n = 1-9]

default n=5

Setting of DTMF tone duration in numbers dial.

Time is $50\text{ms} + n \times 10\text{ms}$, $n=1 - 60\text{ms}$, $n=6 - 110\text{ms}$

4.8.8 AT@P07n - OK

[n = 1-9]

default n=5

Setting of DTMF space duration in numbers dial.

Time is $50\text{ms} + n \times 10\text{ms}$, $n=1 - 60\text{ms}$, $n=6 - 110\text{ms}$

4.8.9 AT@P08n - OK

[n = 1-9]

default n=8

Setting of pause duration in numbers dial.

Time is $500\text{ms} + n \times 100\text{ms}$, $n=1 - 600\text{ms}$, $n=6 - 1100\text{ms}$

4.8.10 AT@P09n - OK

[n = 1, 0]

default n=1

It enables shorter time detection of serial number in automatic mode. It is time after sending of confirmation character when unit is waiting for receipt of serial number. On picture 1 is this parametr marked 10 and 14.

Time is 1250ms for $n=1$ a 2500ms for $n=0$

4.8.11 AT@P10n - **OK**
[n = 1-9] **default n=2**

Setting of DTMF tone duration in sending of DTMF CLIP.
Time is 50ms + n x 10ms, n=1 – 60ms, n=6 – 110ms

4.8.12 AT@P11n - **OK**
[n = 1-9] **default n=2**

Setting of DTMF space duration in sending of DTMF CLIP.
Time is 50ms + n x 10ms, n=1 – 60ms, n=6 – 110ms

4.8.13 AT@P12nn - **OK**
[nn = 01-59] **default nn=24**

Setting of seizure duration in sending of FSK CLIP.
Time is 10ms + nn x 10ms, nn=01 – 20ms, nn=24 – 250ms

4.8.14 AT@P13nn - **OK**
[nn = 01-59] **default nn=11**

Setting of mark duration in sending of FSK CLIP.
Time is 10ms + nn x 10ms, nn=11 – 120ms, nn=24 – 250ms

4.8.15 AT@P14n - **OK**
[n = 1-9] **default n=3**

Setting of BlackBox inquiry number for serial number by confirmation character.
Therefore it is min 2x times from reason of verification the first inquiry is mandatory and furthers are adjustable – n=1-9
Number is n + 1, n=1 – 2 inquiry, n=9 – 10 inquiries

4.8.16 AT@P15nn - **OK**
[nn = 01-30] **default nn=24**

Setting of time when is silent on picked up external line. Valid for TYPE0 only (service and alarm calls). It means time to hang up external line after serial number detection. This parametr has sense for NLLW which has not programmed confirmation for service or alarm calls. Then silent is necessary for call detection. který nemá nastavené pro servisní nebo poruchové volání potvrzování, pak je ticho (repeatation is canceled).

Time is nn x 0,3sec, nn=03 - 1sec, nn=18 - 6sec

4.8.17 AT@P16nn...n - **OK**
[nn...n = 00-999999] **default nn...n=66**

Make saving of confirmation character to memory for automatic mode.
Confirmation character includes * and 2 – 6 digits. nn are only numbers follow after *.

4.8.18 AT@DEFAULT - **OK**

Make default setting. The default setting values are mentioned at each parametr.

4.9 Answers

4.9.1 POL , RING

In case BlackBox is not in automatic mode the incoming ringing from external line send RING (duration of ring signal is longer than 200ms) or POL (ringing detection is

shorter than 200ms). The POL means jump voltage change on the line – change polarity for example: before CLIP FSK receiving in British Telecom format.

4.9.2 FSKC

FSK CLIP receipt was evaluated.

4.9.3 DTMC

DTMF CLIP receipt was evaluated.

4.9.4 CLIPnn...n

Received CLIP number is nn...n, the length of number is max. 24 digits.

4.9.5 DATEmmddhhnn

Received date and time of CLIP and format means mm – month, dd – day, hh – hours, nn – minutes. The length is always 8 digits.

4.9.6 NAMEtt...t

Received name (text) in CLIP, tt...t is text up to 20 characters.

4.9.7 WAIT RST

It is sending by 1 sec after command message recording – via. page11, until signal RST is not changed from „0“ to „1“. Then is starting recording and sending WAIT RST is ended.

4.9.8 END

END is send after call ending (disconnection of loop) after command CONN – via page .8.

4.9.9 FULL

During DTMF CLIP receipt can be filled buffer which is for 16 digits. When is received 16th digit the FULL is sent. You have to read buffer afterward and initialize receipt again. You can continue in dial receiving. Via page **.Chyba! Záložka není definována..**

4.9.10 ERR

After inserting incorrect command or command wasnt processed from any reason the BlackBox send ERR as information about error.

4.9.11 NOLINE

When is insert command for pick up external line for example. ATA via page .7, and when is not current in closed current loop the Black Box inform about not connected line by sending NOLINE.

4.9.12 VER:x.x , RESET

If in BlackBox from any reason reset is done then is sent in 2 rows firmware version x.x and RESET. Reset can happen during switch ON, after RESET command via page7 and at least when firmware is blocked (when firmware is lost, some interference or overvoltage can blocked the firmware) then is automatically done reset.

4.9.13 PICK , HANG

PICK is sending by BlackBox when internal line is picked up (lift up the phone) and HANG during disconnection of internal line (hang up the phone).

5 Technical parametres

BlackBox

Type	analog line
Working position	various
Dimensions	112x148x50 mm
Weight	210 g

Feeder (adapter)

Feeding voltage	230 V~ (+15%, -10%)
Power	max. 10 VA
Weight	390 g
Protection	thermal, short circuit

Public line

Number	1
Impedance and dial by CONN	according device at extension, Attenuate = 0dB
Impedance and dial by CONI	Attenuate = typ. 4 dB
Impedance	600 Ω \pm 20%
Signalling	425Hz \pm 10%
Line current	15 mA - 60 mA
Line voltage	20V - 60V
Ring detector sensitivity	20V - 90V, 25 Hz - 60Hz
CLIP detector	DTMF, FSK Bell core, British Telecom

Extension

Number	1
Impedance	600 Ω \pm 20%
Dial	tone (DTMF)
Resistance of subscribers conduction	max. 500 Ω
Line voltage	24V
Line current	25mA - 30mA
Signalling	425Hz \pm 10%
Generator CLIP	DTMF, FSK Bell core

Connection

USB Communication speed	USB 1.1
External accoustic source	Connector Jack 3.5mm
Accoustic level of external signal	400mV / 10K Ω

6 Program BlackSet

6.1 Select device



6.2 Record message to OGM module



6.3 Manual transmits and receive commands

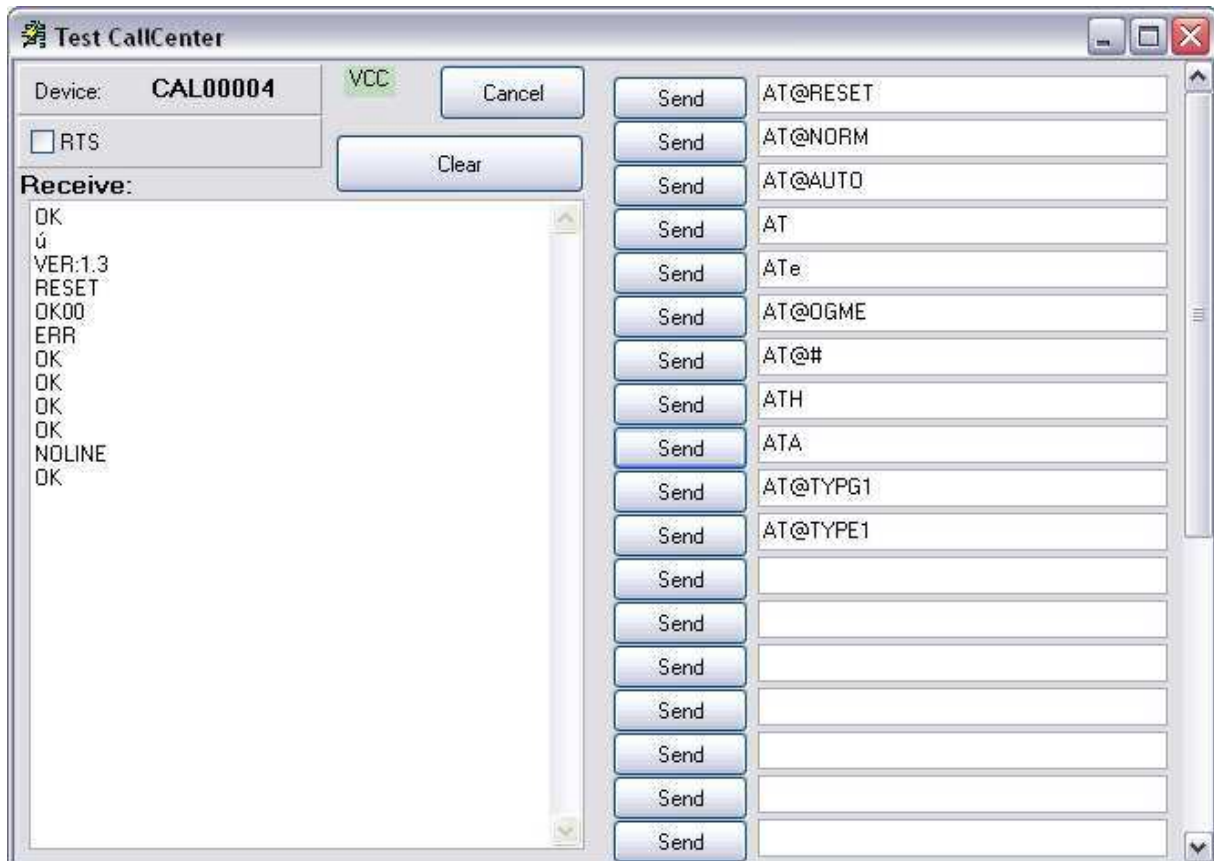

6.4 Easy setting

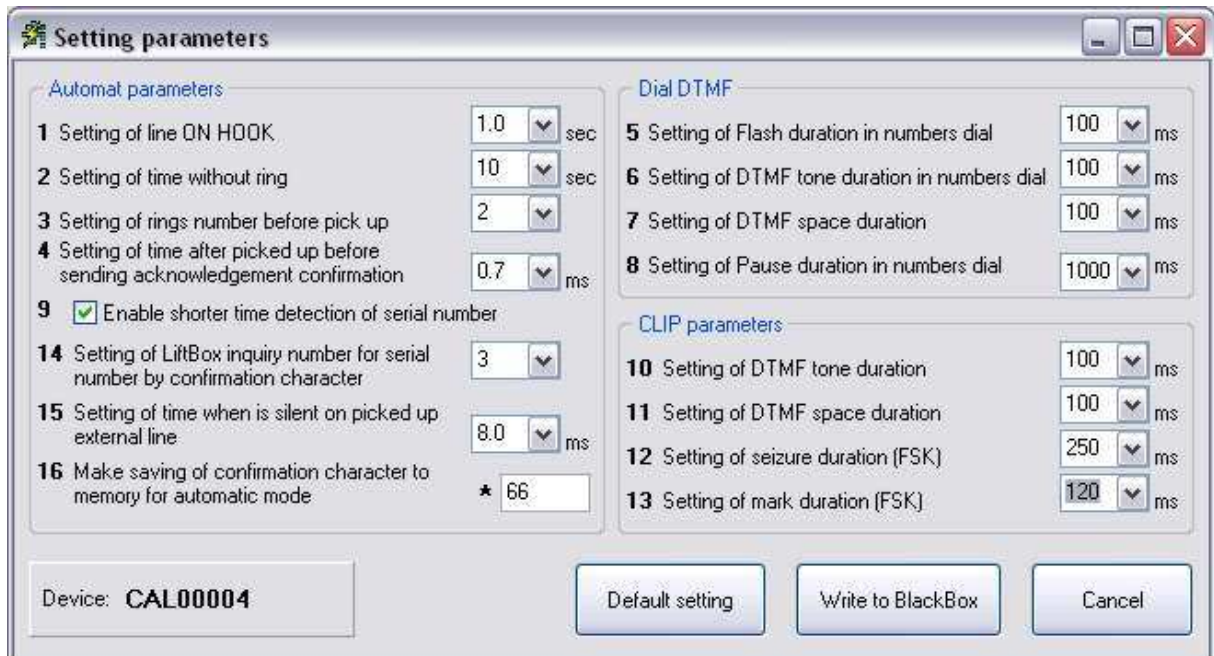

6.5 Firmware update

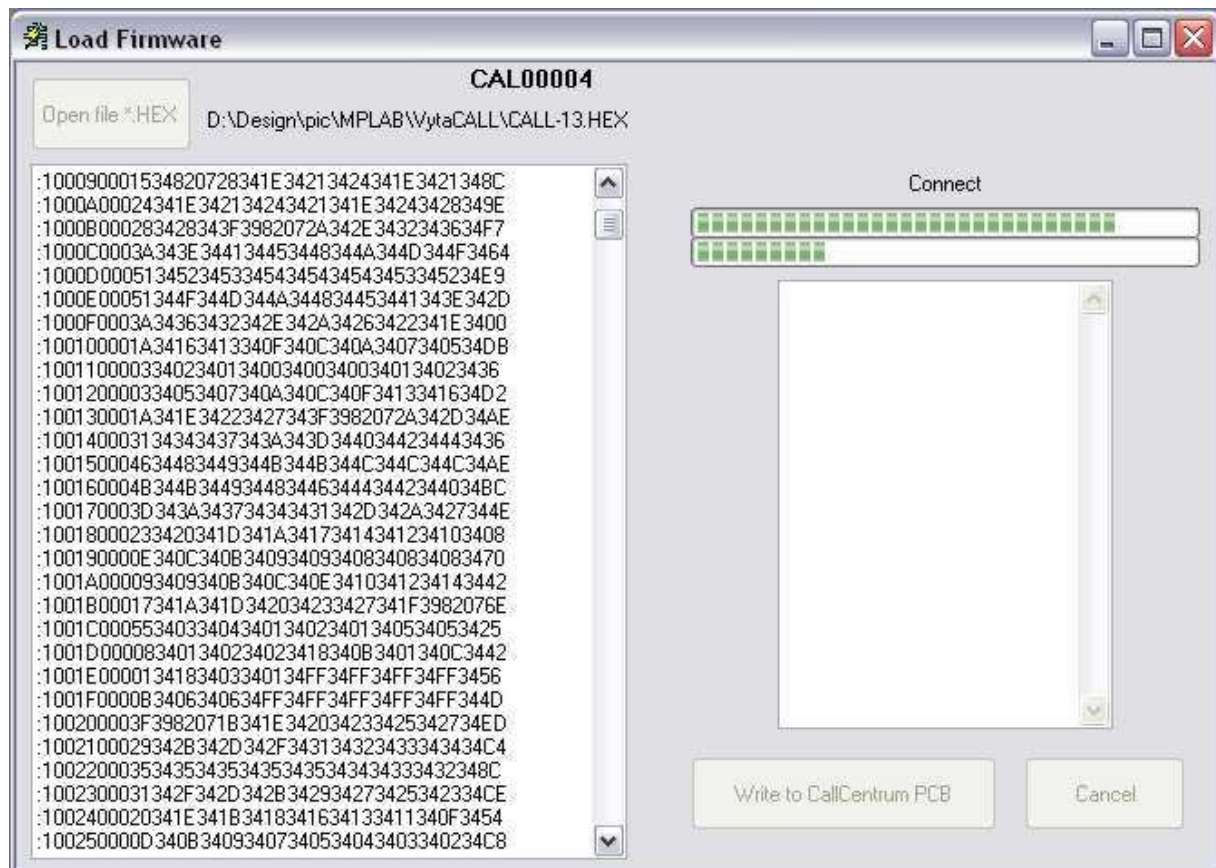

7 Program AlphaLift – connect BlackBox in network

Principle connection separate communicators

on CallCentre in the event of utilize wireless (GSM) transmission. Communicators NLLW contain serial number ID, to was possible localize lift cabin in the event of connection communicators on PBX . Emergency and service calling they are receiving by force of GSM gate and needed data about talk transfer to the accounting computer BlackBox connect by USB. Emergency calling are disposition on telephone set assistant of control, which transact call with persons in cab box. Error SMS are to the CallCentre transmission by force of GSM modem, which is connected interface RS232 (it is possible connect also on USB by force of reduction RS232-USB).

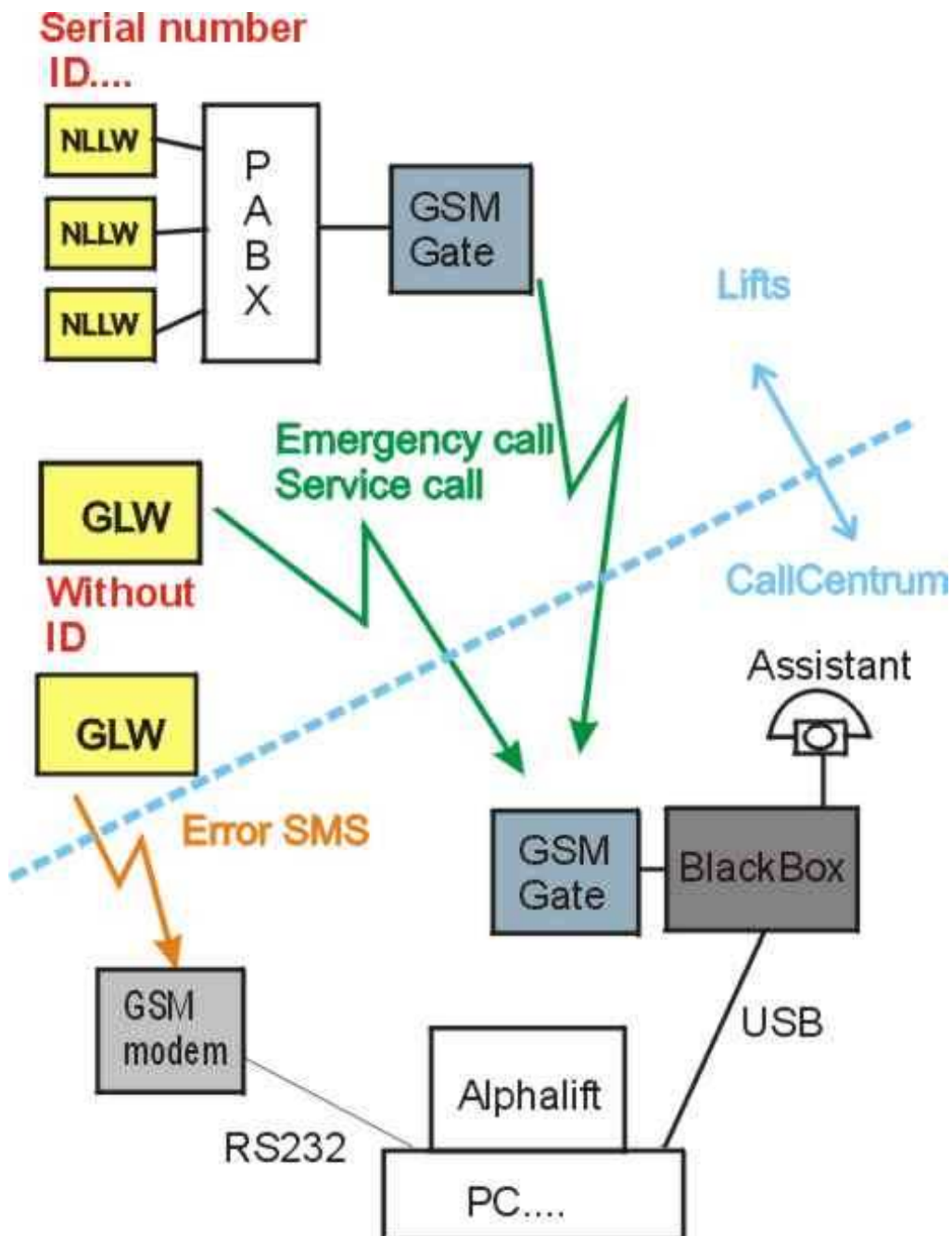

All computer approach (terminal PC and server) to common database that way, that AlphaLift.EXE is the only file in all of network (ISN'T duplication on Terminal PC 1...n) and other computer start application in a way - find on terminal PC ways in network to file AlphaLift.exe on server, on desktop create associate and program start by this associate. Even to expansion field "Description" on more than 255 char - it leads to memo field and because database with memo field in network running is susceptible on failure format, that I would recommend use on PC server application Microsoft: SQL server.

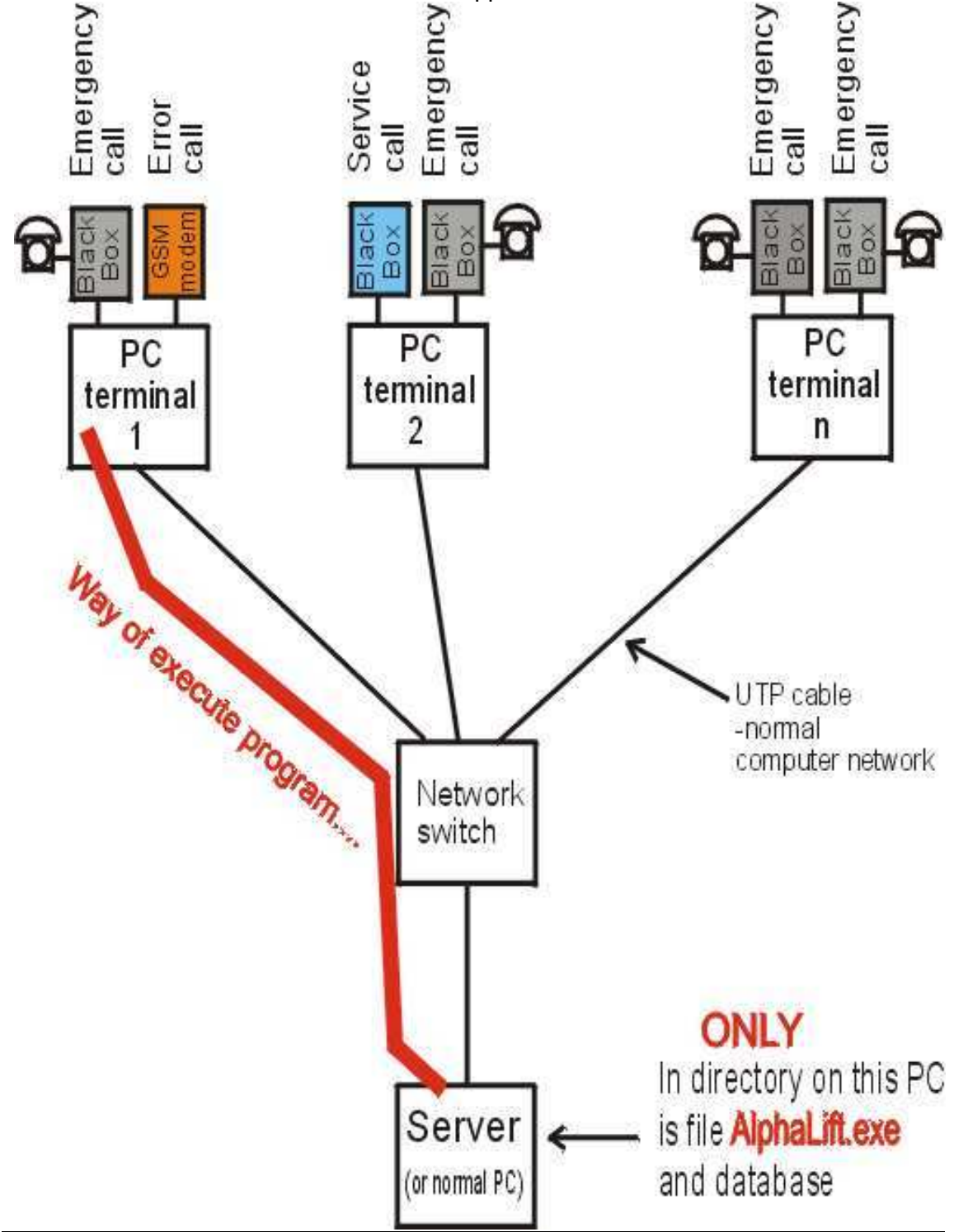

ALPHATECH TECHNOLOGIES s.r.o.

Jeremenkova 88
140 00 Praha 4
Czech Republic
VAT: CZ27577350

Company is registered in the Commercial Register administered by the Municipal
Court in Prague, Section C, Record 116886

Banking details:

Komerční banka, account No. 43-7671450207/0100
IBAN: CZ0801000000437671450207
SWIFT: KOMBCZPPXXX