



GSM Key Switch

GSM remote control



User's manual v3.0



Basic technical parametres:

Power supply	9 to 15V ss, 500mA
GSM network	900/1800MHz
dimension:	145 x 75 x 30 mm

Features :

- Power supply from distribution net 12V or alternative from main power supply (12V adapter). Also can be used backup battery 12V with charging adapter.
- 2 inputs for switching contacts (alarm output, sensors etc.) (5V)
- when is short circuit at input preprogrammed SMS is sent to preprogrammed number (for each input own text SMS as same as number)
- when is short circuit at input progressive ringing up 8 preprogrammed numbers (ALARM1 to ALARM8)
- 2 galvanically separated (switching contacts 230V/ 5A)
- 2 switching contacts control by ringing only from authorised numbers (contact closed for preprogrammed fix time)
- The size of authorised numbers is limited by SIM card capacity (250). The numbers can be saved under different names
- Both outputs control by SMS from numbers authorised in II. level (ALARM). It is possible remotely control closing, disconnection, closing for 1-99 minutes
- Setting of all parametres (authorised numbers, unit time, competence etc.) a s same as complete control of the unit (for example: remote dialling different number from preprogrammed) by SMS from authorised numbers in level III. (ADMIN)
- Cchecking of credit level. Sending of SMS coming from operator to preprogrammed number.
- Setting of all parametres via PC through RS 232 port. All parametres can be programmed directly on SIM by mobile phone or remotely by SMS
- Systém interface for optional devices

Installation

The unit may be installed on DIN ribbon, screw on the wall or put to the shelf. The unit is not designed for installation in high humidity environment. If you want install it in external environment you have to fix it into waterproof box.

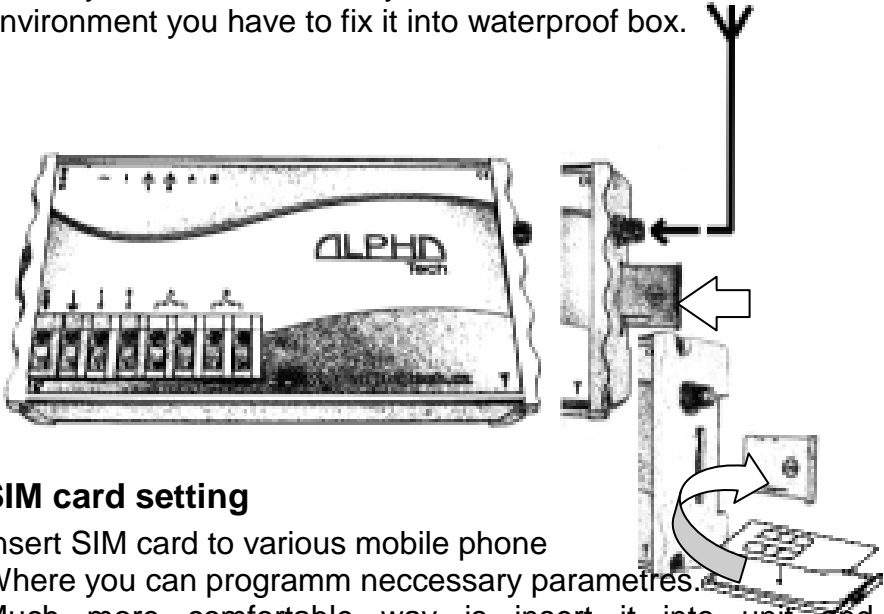

SIM card setting

Insert SIM card to various mobile phone

Where you can programm necessary parametres.

Much more comfortable way is insert it into unit and parametres programm via PC through attached programming cable. For PC setting use configuration software on CD which is attached to the unit.

CAUTION! On the SIM card must be saved at least 1 phone number when you want control relay by ringing. Further more at least 1 ADMIN phone number, when you want remote control of the unit. At least ALARM1 phone number, when you want receive call after input activation. THE NUMBERS MUST BE IN INTERNATIONAL FORMAT!

Inserting of SIM card into unit

Pull out SIM card holder by pressing of yellow button on right side of the unit. The SIM card put to holder and replace it.

Schematics of feeding with delivered power supply

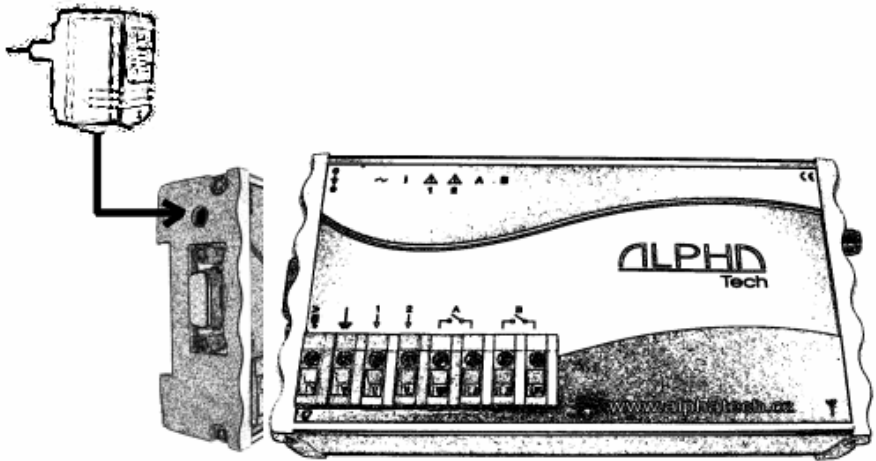

Schematics of feeding with charging power supply and backup 12V ACU

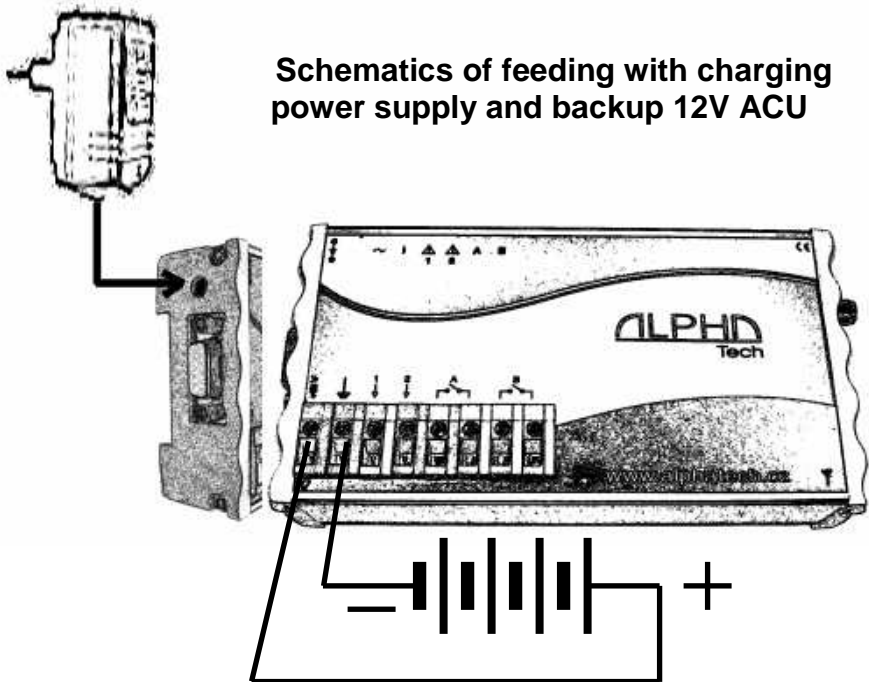

Schematics of feeding from 12V distribution

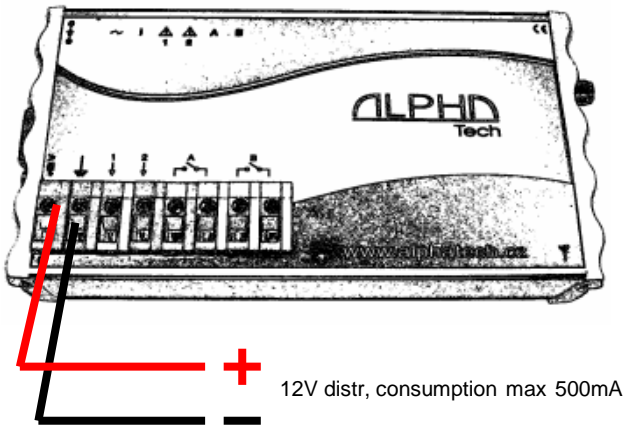

Schematics of Inputs/Outputs

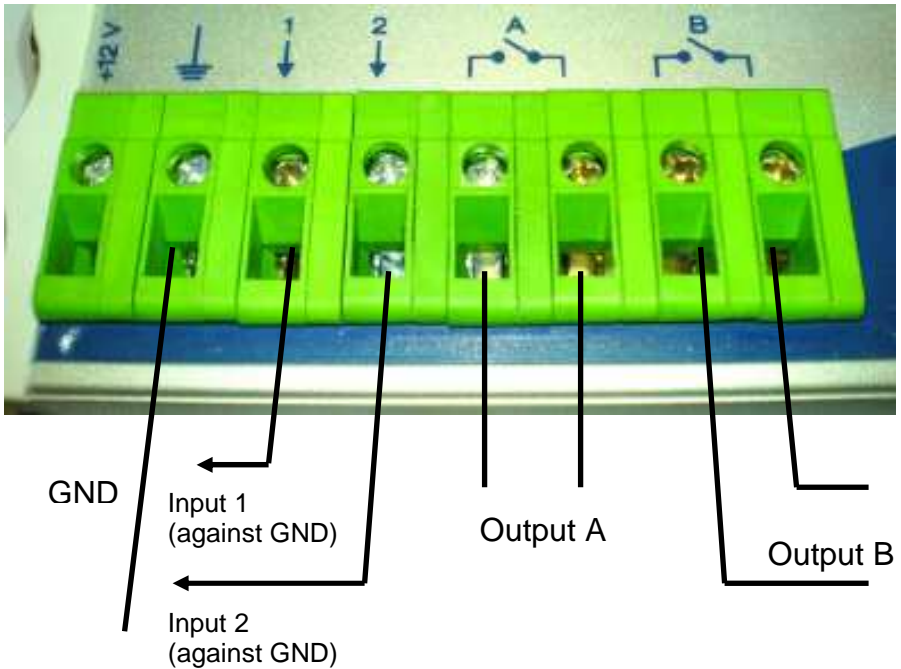

Inputs connection examples:

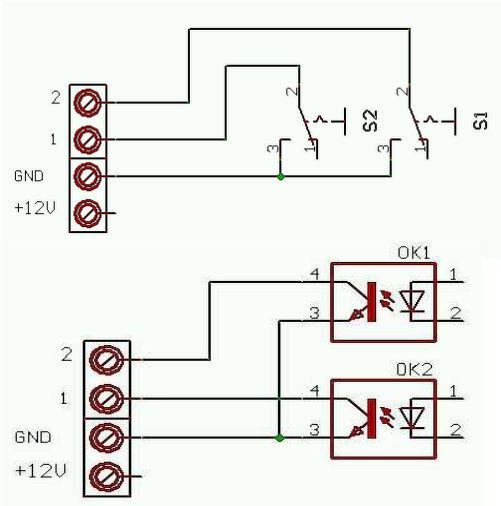

Connection with relay contacts, switches, magnetic contact switchers etc.

Connection of galvanically isolated switch with optotransistor

Outputs connection examples:

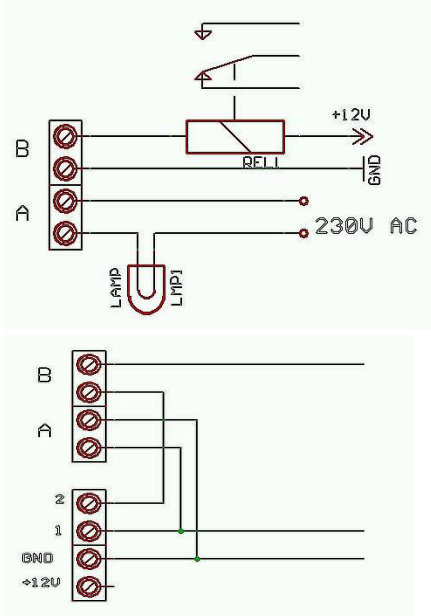

High power relay (clamber) connection , lightbulb connection (heating, engine etc.).

Selftest Input 1 (due relay A) – possibility activate Alarm remotely, Blocking Input 2 (due relay B) – Remote control of alarm circuit = Guarding for limited time

Indication LED

Blue LED

Lighting – feeding from power supply
Flashing – feeding from Backup ACU

Yellow LED

Short flashing – GSM network search
Slow flashing – GSM network ready
Fast flashing – SIM card error

Red LED

Lighting during input activation

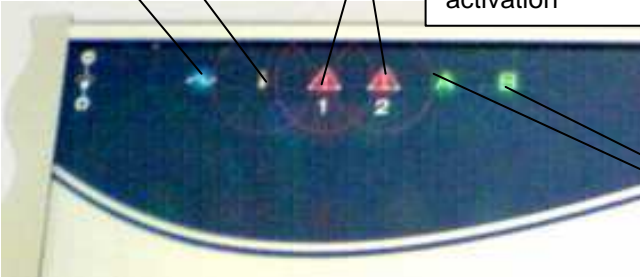

Green LED

Flashing – output permanently closed
Lighting – output closed for mm minutes

Names and numbers to save on SIM card

Name	functionality
various	By ringing activate output A (closing time set in RTIME)
ALARM1 to ALARM8	<ul style="list-style-type: none"> - By ringing activate output A (closing time set in RTIME) - By SMS activate output A and B - By SMS control (status, version, IMEI, credit) - During failure on input 1(2) is send SMS from position 2(3) and progressively ring to line of ALARMx numbers (until line interruption) - when power supply is disconnected for 30 sec. and more the SMS in format 'ACCU,credit' is sent to ALARM8 number - when power supply is working again longer than 30 sec. the SMS in format 'POWER ON,credit' is sent to ALARM8 number
ADMIN1 to ADMIN8	<ul style="list-style-type: none"> - By ringing activate output A (closing time set in RTIME) - By SMS activate output A and B - By SMS control (status, version, IMEI, credit) - By SMS edit numbers and names saved on SIM card - By SMS control further functions (AT commands)
CRED	<ul style="list-style-type: none"> - code to assure credit level (*101# ... for T-MOBILE, *104*# ... for O2)
OPER	<ul style="list-style-type: none"> - GSM operator number where from coming inform SMS (expiration time etc..). The SMS is resent to ALARM8
RTIME	<ul style="list-style-type: none"> - Time of closing output A after ringing (1-99sec), default 3sec

The name and numbers may be saved to SIM card phone book by mobile phone or by PC via configuration sw. **The names ALARMx, ADMINx, CRED, OPER and RTIME must be written by BIG characters. Between name ALARM and number (ALARM1,2...) as same as ADMIN (ADMIN1,2..) must not be a space. The ALARM numbers must have voice mail switch OFF! When ALARM number is busy or unreachable the call is picked up by voice mail and further numbers are not ringed!**

Alarm SMS send during input activation is possible programm by PC configuration software only.

Command SMS – SMS with other content are refused

Command (SMS)		Function	response
SMS is possible send from ADMIN numbers only!	ADMINx,+420cc...c	Save or rewrite ADMINx number	'OK,credit'
	ADMINx,	Erase ADMINx number	'OK,credit'
	ALARMx,+420cc...c	Save or rewrite ALARMx number	'OK,credit'
	ALARMx,	Erase ALARMx number	'OK,credit'
	CRED,x..xx	Save or rewrite CRED number	'OK,credit'
	CRED,	Erase CRED number	'OK,credit'
	OPER,x..xx	Save or rewrite OPER number	'OK,credit'
	OPER,	Erase OPER number	'OK,credit'
	RTIME,ss	Time closing of output A during ringing (ss=01..99 sec)	'OK,credit'
	SMSx,x..x,text	Save SMS on position x (1-6)	'OK,credit'
	SMSx,	Erase SMS on position x	'OK,credit'
	NAME,+420cc....c	Save phone number for NAME	'OK,credit'
	NAME,	Erase all numbers with NAME	'OK,credit'
	NAME,+420cc....c-DEL	Erase exact number with NAME (may exist more times !)	'OK,credit'
	CAL,AT+CSQ	Valuation of GSM signal strenght	'+CSQ,17,99,credit' (max 32)
	CAL,AT+CPBR=x	Detection of number saved on position x	'+CPBR:1,"+421012345678",145,"ADMIN1"
Valid for ALARM numbers	STAT	Status inquiry	'status,verze,i mei,credit')*
	REL1,ON	Activate relay 1 (Output A)	'OK(REL1,ON),credit'
	REL1,OF	Deactivate relay 2 (Output A)	'OK(REL1,OF),credit'
	REL1,ON,mm	Activate relay 1 (Output A) for time mm, where mm=01..99 min	'OK(REL1,ON,mm),credit'
	REL2,ON	Activate relay 2 (Output B)	'OK(REL1,ON),credit'
	REL2,OF	Deactivate relay 2 (Output B)	'OK(REL1,OF),credit'
	REL2,ON,mm	Activate relay 2 (Output B) for time mm (mm=01..99 min)	'OK(REL1,ON,mm),credit'

Note:

- credit** The level of remaining credit on prepaid cards.
- x..xx** telephone number
- text** text of SMS message
- SMS1** SMS message sent when unit is switch ON
- SMS2** SMS message sent during activation input 1
- SMS3** SMS message sent during activation input 2
- SMS4-6** back up for OEM messages
-)* **status** – Inputs as same as outputs status in order INPUT1, INPUT2, RELAY1, RELAY2.
 - INPUTx = 1 – stand by
 - 0 – alarm status
 - RELAYx = 0 – switch off
 - 1 – switch on permanently
 - 2 – switch on for time 'mm'
- verze** – firmware version
- imei** – IMEI of integrated GSM modul
- CAL,** after command CAL you can put various AT command of used GSM modul (for example: modul reset , time setting etc...) . **The commands should be used by authorised person only! It may cause damage of all unit!**

Closing contacts by ringing

The relay outputs might be closed on 2 sec (or time RTIME) by ringing from various number saved on SIM card (Even ALARM and ADMIN). The output A is closed by direct ringing, Output B by „diverted ringing“. To create „diverted ringing“ we have to get next telephone number (called „X“) , on which we activate permanent divert to number used in GSM Key. To close output B we do not call number in GSM Key but number „X“ – follow is managed by GSM Key and GSM operator.

How you can get further phone number? The best is to manage next SIM card on which you activate permanent divert. However you have further options. The second number

on current SIM card (data number, fax number, second number – depends on GSM operator services and prices). When you want control output B by SMS the second number is not necessary.

Example of real operation

At enter to your house you have connected output A to open your gate. The output B is used for deactivation Alarm system (Alarm systém OFF during time of relay closing). Input1 connected to alarm of your security systém and input 2 to humidity (fire) sensor.

You will save to the unit (SIM card) your mobile number as ADMIN1 and ALARM1. The mobile your wife save under various name. Programm appropriate format of SMS for both inputs (for example. “ALARM!” and “CAUTION high water level!”) with number of your mobile phone. To your as same as wife mobile save number of the unit (SIM) to speed dial.

Now you dont need 2x radio controller for Gate opening. You are coming (or wife), give a ring to the unit, units detects your CLIP and reject your call (it is for free) . The Gate is opening.

You are working. Your mobile is ringing. You see Name of your unit! SMS! ALARM! Mobile ringing again: neighbour – “Your Alarm is screaming again!! Do something !!! Next call coming – your wife, “Dear? I probably forgot to switch off the alarm and I am not able to manage. I returned home for..... and I am just leaving!” You are quite. Select prepared SMS “REL2,ON, add 60 (because you know „just leaving“ takes cca 45 minutes) and send to the unit. The unit response by SMS “OK(REL2,ON,60) – command confirmation.

It should come new gardener Mr. Parker (for example) to cuth the grass and plant saplings etc.. You send from your mobile SMS: Parker,+420123456789. Since now Mr. Parker can control your gate as well. After his job is ending you will erase similiary his name from phonebook.

Obviously you have the same unit in company(you will not use a few radio controllers???. When all you manage by your mobile phone). It is evening. At home is celebration. You get a call: “ We just arrived with material but store is closed. You have to come and open it!

No, you dont!

Just give a ring to the unit from your mobile phone!

PC programming by configuration sw.

Installation and uninstallation of software

2 files (file with end .exe and file with end .ini). From selected language spot on CD copy to chosen (or created) directory in your PC. During first run programm creates all necessary files in this directory. When you copy file .exe only the english language version will be created.

By erasing of this directory you uninstall all application.

PC connection tool

The operating unit (switched ON) connect to PC via supply USB cable (you have to install USB driver from attached CD) or via serial cable + special convertor (see on picture).

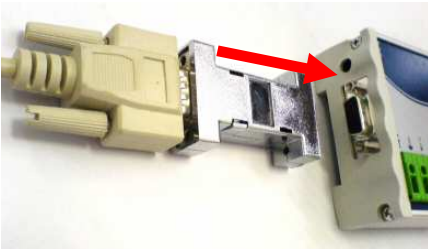

Run the programm and select serial port where unit is connected

Basic window of the programm

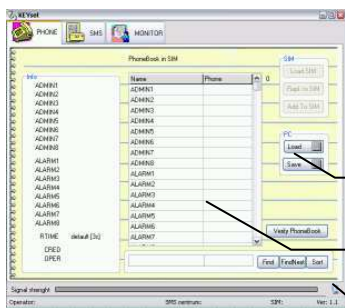

Until connection is established (max. 30sec) some elements are not active.

Save and read phone book

Prepared blank phone book

Symbol to show searching of unit to establish connection

The basic window after connection PC with unit

Button to work with SMS

Button to work with Phone book

Button to monitor seriál communication

Load phone book from SIM card

Overview of important item in phone book

Preset relay closing by ringing

Name	Phone
ADMIN1	+420739220775
ADMIN1	+420739220775
ADMIN1	+420739220775
ADMIN1	+420739220775
ADMIN1	+420739220775
ADMIN1	+420739220775
ADMIN1	+420739220775
ADMIN1	+420739220775
ADMIN1	+420739220775
ADMIN1	+420739220775
ADMIN1	+420739220775
ADMIN1	+420739220775
ADMIN1	+420739220775
ADMIN1	+420739220775
ADMIN1	+420739220775
ADMIN1	+420739220775
ADMIN1	+420739220775
ADMIN1	+420739220775
ADMIN1	+420739220775
ADMIN1	+420739220775
ADMIN1	+420739220775

Re-write phone book on SIM

Add to phone book on SIM

Items number in phone book

Signal strength [Green bar]

Operator: "EUROTEL - CZ" SMS centrum: SIM: 250 Ver: 1.0

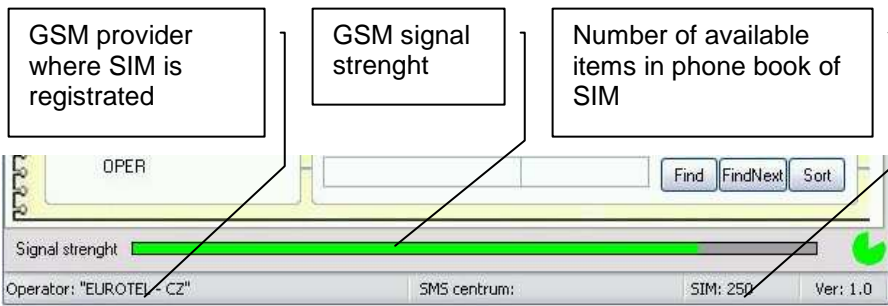

Program monitors communication microprocessor with GSM module . It shares this communication way to module. Microprocessor works with GSM module in 30 sec. period. It means that program has periodically 30 sec. For its own communication (loading or saving numbers) as same as SMS to SIM of the unit. This time is shown by green point in right down corner of program. Out of this time (while microprocessor works with GSM module) are some features unavailable.

Phone book work

After program running is shown empty phone book with preprogrammed important names (ADMIN, ALARM, CRED etc.). To selected name you can order desired number. Those complete twins are shown in neighbour informed panel. New names you can write to right column. You can also rewrite already saved names and numbers. By insert button you can add new row in various position of table. When you erase name or number the row is deleted when you move cursor. During work with phone book are all inserted data control (format, etc..). Exception are numbers OPER and CRED which can content further characters (*,#) up specification of GSM provider and RTIME (time in sec.)

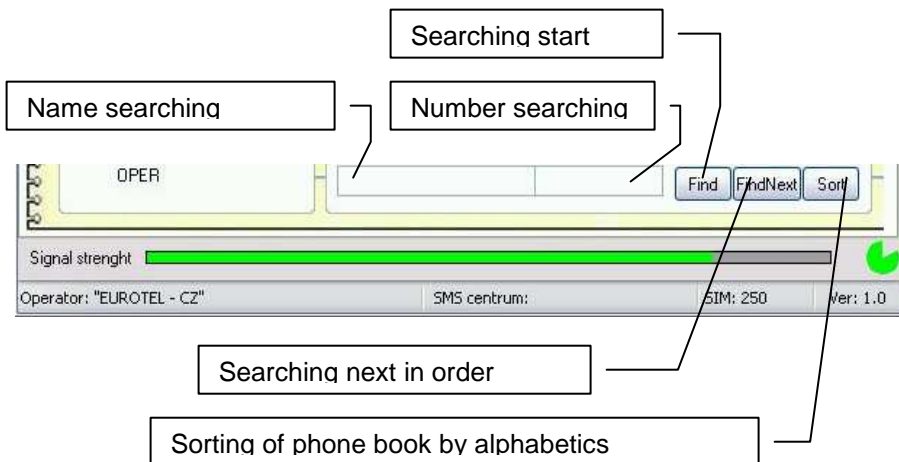

In phone book you can search items up names (or its part) or up phone number (or its part).

Phone book you can save to PC where you can use various text editor to make corrections.

After loading of phone book use button for verification of correct data format.

Phone book you can download also from SIM card.. You can add or rewrite phone numbers and names. Saving to SIM takes longer time (minutes) when phone book is longer than 100 items. The process of phone book saving is display by scale in bottom part of basic window. While phone book is saving control elements are blocked.

Phone book size is limited by SIM card capacity (usually 250 items). SIM card capacity is shown on bottom bar of basic window.



SMS messages work

Window to work with SMS is opened after click to SMS button in basic window.

The screenshot shows the 'KEYset' software interface with the following callout boxes and their corresponding functions:

- Erase all messages from SIM**: Points to the 'Delete SMSs' button.
- Save written SMS to SIM**: Points to the 'Save SMSs' button.
- Reading of all messages from SIM**: Points to the 'Load SMSs' button.
- SMS sent when unit start works**: Points to the 'SMS Start' field.
- SMS sent when input 1 is activated**: Points to the 'SMS Input1' field.
- SMS sent when input 2 is activated**: Points to the 'SMS Input2' field.
- Unactive SMS for future features**: Points to the 'SMS blank1', 'SMS blank2', and 'SMS blank3' fields.
- Display all SMS on SIM**: Points to the 'SMSs in SIM' list.
- Load and save SMS from PC**: Points to the 'Load' and 'Save' buttons under the 'PC' section.

The interface includes a menu bar with 'PHONE', 'SMS', and 'MONITOR'. The main area contains fields for 'Phone:' and 'Text:', and a list of SMS messages. The status bar at the bottom shows 'SMS centrum: +420602909909', 'SIM: 250', and 'Ver: 1.0'.

The way of work with SMS is the same like work with phone book.

Service button – seriál communication monitor

It is display complete seriál communication running on seriál bus with GSM modul. It may be saved to file which you can sent for analyse if necessary.

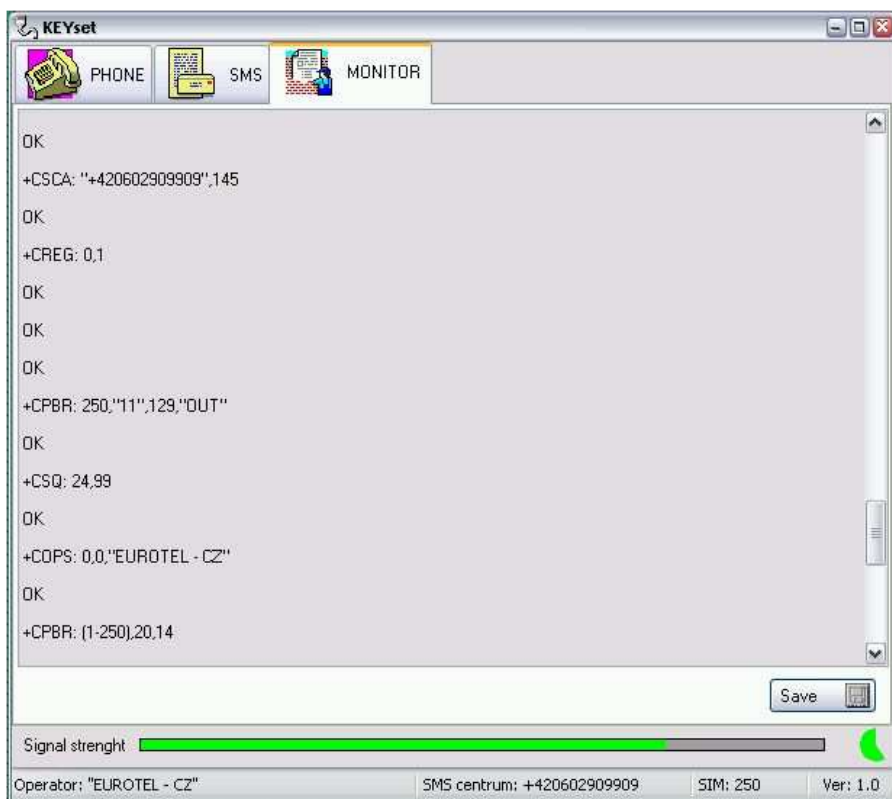

Entry recording („Evidence of access“)

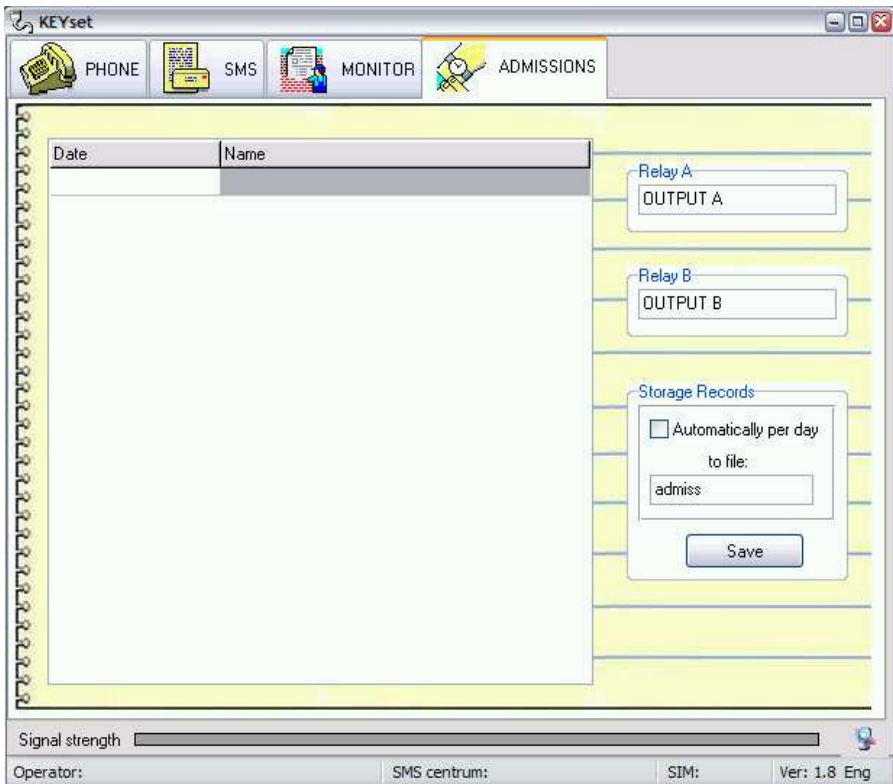

The unit allows recording (when program is permanently connected to unit) each access (relay closing by ring). It records date, time and phone number+name like is saved on SIM card. For better searching in recorded data is possible to put different names for relays A and B (for example: Gate, Entry 1, Entry 2 etc...). The final table you can edit – it means you can write remarks, etc... The table can be saved manually or automatically (adjustable). Then is created new file for every day with selected name includes appropriate date. The records are saved in *csv format – you can process in Excel or Access afterward.



ALPHATECH TECHNOLOGIES s.r.o.
Jeremenkova 88, Praha 4, Czech Republic
www.alphatechtechnologies.cz

ALPHATECH TECHNOLOGIES s.r.o.

Jeremenkova 88
140 00 Praha 4
Czech Republic
VAT: CZ27577350

Company is registered in the Commercial Register
administered by the Municipal
Court in Prague, Section C, Record 116886

Banking details:

Komerční banka, account No. 43-7671450207/0100
IBAN: CZ0801000000437671450207
SWIFT: KOMBCZPPXXX

